

Equilibrium Conformations of Four- and Five-Membered Cyclic Molecules in the Gas Phase: Determination and Classification

A. C. LEGON

Christopher Ingold Laboratories, Department of Chemistry, University College London, London WC1H 0AJ, United Kingdom

Received December 10, 1979

Contents

I. Introduction	231
II. Conformation in Four- and Five-Membered Rings:	232
Definition and Consequences	
A. Potential-Energy Function, Conformation, and Equilibrium Conformation	232
B. Model Potential-Energy Functions and Their Implications	232
1. Introduction	232
2. One-Dimensional Approximation for Four-Membered Rings	232
3. Two-Dimensional Approximation for Five-Membered Rings	234
III. Experimental Determination of Ring Conformation and Geometry	235
A. Introduction	235
B. Vibrational Spectroscopy	236
1. Far-Infrared Spectroscopy	236
2. Infrared Spectroscopy	237
3. Raman Spectroscopy	237
C. Rotational Spectroscopy	237
1. Effective Rigid-Rotor Approximation	237
2. Non-Rigid-Rotor Behavior	239
D. Electron Diffraction	239
1. Geometrical Parameters r_a , r_g , r_α , and r_α^0	239
2. Comparison of Geometries from Spectroscopy and Electron Diffraction	240
IV. Factors Controlling Conformation in Four- and Five-Membered Rings	240
A. Introduction	240
B. V_d and Ring Angle Strain	240
C. V_t and Torsional Forces about Ring Bonds	240
D. Effects of Substitution of Ring Atoms on $V(x)$	241
1. Replacement of a Tetrahedral Carbon Atom by a Trigonal Carbon Atom	241
2. Isoelectronic Substitution of CH_2 by NH , O , etc.	241
E. Other Factors	241
V. Experimental Conformations of Four- and Five-Membered Cyclic Molecules and Their Classification	241
A. Introduction	241
1. Classification	241
2. Construction of Tables	242
B. Four-Membered Rings	242
1. No Endocyclic Trigonal Carbon Atoms	242
2. One Endocyclic Trigonal Carbon Atom	242
3. Two Endocyclic Trigonal Carbon Atoms	246
4. Four Endocyclic Trigonal Carbon Atoms	246
5. Exocyclically Monosubstituted Cyclobutanes	246
6. Molecules Based on Diborane	247
C. Saturated Five-Membered Rings	247
1. No Endocyclic Trigonal Carbon Atoms	247
2. One Endocyclic Trigonal Carbon Atom	250
3. Two Endocyclic Trigonal Carbon Atoms	251
D. Five-Membered Rings with One Endocyclic Double Bond (Pseudo-Four-Membered Rings)	251
1. Two Endocyclic Trigonal Carbon Atoms	251
2. Three Endocyclic Trigonal Carbon Atoms	252
3. Four Endocyclic Trigonal Carbon Atoms	252
E. Five-Membered Rings with Two Endocyclic Double Bonds	254
VI. Conformations of Four- and Five-Membered Rings in Bicyclic and Polycyclic Compounds	254
A. Introduction	254
B. Bicyclic Compounds Containing Four-Membered Rings	254



A. C. Legon was born in Suffolk, England, in 1941 and received his chemical education at University College London where he is Lecturer in Chemistry. His research interests are in the elucidation of the potential energy function for isolated hydrogen-bonded dimers and small-ring compounds by spectroscopic means. He is currently pursuing the former interest during a year's leave of absence spent in the School of Chemical Sciences, University of Illinois, Urbana.

C. Bicyclic Compounds Containing Five-Membered Rings	256
D. Tri- and Tetracyclic Compounds Containing Four- and Five-Membered Rings	258
VII. Addendum	258
VIII. References	258

I. Introduction

Paths presenting low energy barriers to conformational change in molecules and the effect of changes in chemical constitution on these are of special interest to chemists and biochemists, particularly in the case of large naturally occurring compounds. In order to understand such phenomena in complicated molecules, however, it is necessary to consider simple models. Four- and five-membered rings are particularly important in this respect because they can have, as a result of a delicate balance of opposing factors, two (or more) stable conformations (corresponding to potential-energy minima) which differ little in energy. Moreover, the shape of the potential-energy surface in the region of a minimum associated with a given conformer can endow the compound with distinctive spectroscopic properties, the analysis of which allows the nature of the surface to be diagnosed.

In the case of four-membered rings, the link between these distinctive spectroscopic properties and the nature of the surface was first forged by Gwinn and co-workers¹⁻⁴ in a definitive series of papers on oxetane. They showed that the potential energy varies with essentially the fourth power of the ring-displacement coordinate in a manner similar to that proposed by Bell,⁵ except that there exists a tiny barrier to the planar ring. The means of establishing a one-dimensional ring-puckering potential function, and hence the equilibrium conformation, for such a molecule from the effects of a barrier on its spectra are set out in these papers. Later work showed that substitution of ring

atoms leads to changes in the potential function, from which it is possible to deduce the effects of substitution on the factors controlling the conformation.

The distinctive spectroscopic implications of the potential-energy surface governing the puckering modes of five-membered rings were first discovered as a result of a discrepancy between the spectroscopic and calorimetric entropies of cyclopentane. This led Pitzer et al.⁶ to postulate the phenomenon of pseudorotation in which the phase of the puckering progresses around the ring. The detailed general theory for pseudorotation and hindered pseudorotation was systematically developed by Gwinn and co-workers^{7,8} who showed how the two-dimensional potential surface associated with the two ring-puckering modes could be spectroscopically determined. As a result, this surface is known for a number of molecules. A chemically important consequence of pseudorotation is that it provides for certain molecules an alternative low-energy path to the inverted ring conformation which does not pass through the high-energy maximum at the planar ring.

In this review the equilibrium conformations of four- and five-membered ring molecules in the electronic ground state and the gas phase, which are now available for many such compounds as a result of spectroscopic (and electron diffraction) investigations, are discussed. In particular, a classification is presented which allows the conformations of a wide range of cyclic compounds to be rationalized in terms of a few simple controlling factors. The sections preceding the classification review the experimental methods used to determine conformation and the factors that control it. The first of these is without detail but emphasizes how the information most important in understanding the second is obtained. Coverage of this review extends from the late 1950s until November 1979 (i.e., including *Chemical Abstracts* Vol. 91, No. 19).

A convenient classification of experimentally determined ring conformations rests on two factors that control conformation: ring angle strain and the potential-energy barriers to torsional motion about ring bonds. For a given ring, substitution of a tetrahedral ring carbon atom by a trigonal carbon atom increases ring angle strain and reduces the barriers to torsional motion about the bonds involved. Both changes tend to favor the planar ring over the puckered ring. Classification according to the number of trigonal carbon atoms in the ring for each of the two types of ring (four and five membered) thus suggests itself. A subdivision of each class is then possible on the basis of successive substitution of CH₂ groups in the parent compound of the class by the isoelectronic analogues NH, O, etc. If the same order, X = CH₂ > NH > O, holds for the potential barrier to torsional motion about C-X ring bonds as it does for (CH₃)₂X compounds, the replacement of CH₂ groups by NH, O, etc. should progressively favor the planar ring.

II. Conformation in Four- and Five-Membered Rings: Definition and Consequences

A. Potential-Energy Function, Conformation, and Equilibrium Conformation

In order to discuss the experimental determination of conformation and its classification in molecules it is first necessary to define the term conformation. Following Herzberg,⁹ a given conformation of a molecule corresponds to a given relative arrangement of the nuclei. For a molecule in a given electronic state the (potential) energy changes with the relative positions of the nuclei.¹⁰ In general $3N - 6$ internal coordinates are required to describe the relative positions of the nuclei ($3N - 5$ for linear and diatomic molecules), where N is the number of atoms in the molecule. Thus, in the general case, the potential-energy function which governs the motion of the nuclei can be represented by a $3N - 6$ dimensional hypersurface in a $3N$

- 5 dimensional space. Each point of the surface represents a given conformation of the molecule.

In this review, attention is restricted to the electronic ground state, and for all molecules considered the potential-energy surface in this state possesses one or more minima. Classically, molecules which have the conformation corresponding to one such minimum are said to have a stable equilibrium conformation. The internuclear distances and interbond angles appropriate to the minimum define the geometry of the equilibrium conformation in question. Molecules in energy eigenstates cannot take up the equilibrium conformation but in the zero-point vibrational state often have an average conformation which approximates to it.

In considering the conformations of four- and five-membered rings we would like to know such details of the potential-energy surface as the positions of the minima, the height of barriers between the minima, the shape of the minima, and so on. Experimentally, such details can be inferred by making observations of the properties of the molecules in question. Ultimately, the observables will be associated with one or more of the vibration-rotation states of the molecule and are derived from far-infrared, infrared, and microwave spectroscopy and from electron-diffraction experiments. In order to infer the nature of the potential function from the observables, it is necessary to calculate values of the observed quantities by using a model function and to compare them with experiment. A theory is required, therefore, which allows eigenvalues and other properties to be calculated from a proposed potential function.

B. Model Potential-Energy Functions and Their Implications

1. Introduction

A detailed and complete account of the theory and computational methods by which the potential-energy function for a cyclic molecule can be obtained from experimental observations has been given by Gwinn and Gaylord.¹¹ In the present review, therefore, only that theory which is necessary to discuss the experimental results for the molecules under consideration will be given and this without detail.

Infrared and far-infrared spectroscopy (and sometimes microwave spectroscopy) yields vibrational energy separations of such accuracy that, for molecules of the size considered here, only the vibrational Hamiltonian and its eigenvalues need be considered when the data are used alone to derive a potential-energy function. Microwave spectroscopy gives precise information about vibration-rotation interaction and sometimes very accurate vibrational separations. Then it is necessary to solve the eigenvalue problem for the full vibration-rotation Hamiltonian. For four- and five-membered rings the experimental data available are such that in no case has the complete potential-energy function been derived and approximations have been required. The approximate model potential functions that have been used are discussed below. The vibrational eigenvalues that result from the use of a few typical functions under these approximations are also summarized. The results of the vibration-rotation problem under these approximations will be introduced in section III when the determination of potential-energy functions from microwave spectroscopy is discussed.

2. One-Dimensional Approximation for Four-Membered Rings

For an n -membered ring there are $n - 3$ out-of-plane skeletal modes, so that if $n = 4$ there is just one, the so-called ring-puckering (or bending) mode. Experience shows that the fundamental of this mode is usually much lower in frequency than the remaining $3N - 7$ and the vibration is of large amplitude. It has commonly been assumed that the low-frequency, large-

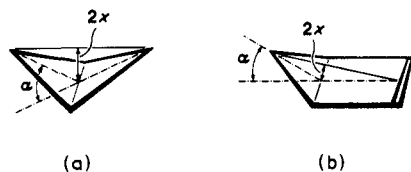

Figure 1. Definition of the ring-puckering coordinate x and the ring-puckering angle α for (a) a four-membered ring and (b) a pseudo-four-membered ring.

amplitude motion can be separated from the remaining high-frequency, small-amplitude motions and treated one-dimensionally to good approximation. If this is the case and x is a suitable ring-puckering coordinate (Figure 1a shows the definition of x that has been used) assumed to approximate to the normal coordinate Q of the mode, the vibrational Hamiltonian is

$$\mathcal{H} = \frac{P_x^2}{2\mu} + V(x) \quad (1)$$

where P_x is the vibrational momentum conjugate to x and μ is the reduced mass for the vibration. For almost all cases investigated in which the planar ring has a plane of symmetry it has been possible to interpret the observables associated with the ring-puckering mode very successfully by using a simple one-dimensional function $V(x)$ of the type

$$V(x) = Ax^4 + Bx^2 \quad (2)$$

where A is a positive constant and B may be a positive or negative constant. If B is positive, the potential function has only one minimum with a curvature and shape controlled by the relative magnitude of A and B . If B is small, the curvature at the minimum is small and the function has steep walls. When B becomes sufficiently large and positive, the form of the potential-energy function approaches that of the harmonic oscillator. If B is negative, however, the function is of the double minimum type, with an energy barrier of height $B^2/4A$ separating the equivalent minima.

The solution of the one-dimensional vibrational eigenvalue problem using potential-energy functions such as that above has been discussed by several authors.^{4,11-14} Only the minimum details necessary will be given here therefore. The Hamiltonian is first reexpressed in terms of a reduced coordinate z by using a transformation of the type

$$x = kz \quad (3)$$

where k is a function of the reduced mass (μ) of the vibration. Several slightly different transformations between x and z have been used, and the relationships among these have been reviewed by Laane¹³ and by Gibson and Harris.¹⁵ As a result of the transformation, the generally unknown μ does not appear explicitly in \mathcal{H} , having been absorbed into the terms P_z and z . The potential energy becomes in terms of z

$$V(z) = az^4 + bz^2 \quad (4)$$

The Hamiltonian matrix can then be set up, usually in a harmonic oscillator basis containing ~ 100 functions, and diagonalized to give the vibrational eigenvalues. Figure 2 shows the pattern of vibrational eigenvalues associated with three different one-dimensional potential-energy functions $V(z)$. In Figure 2a, appropriate to large A and small positive B , the energy levels approximate to those of a quartic oscillator and diverge as the vibrational quantum number v increases. In Figure 2b, the relative magnitudes of A and B are such that a very small barrier, lower than the $v = 0$ level, is present which perturbs the first few eigenvalues but leaves the higher ones essentially unaffected. When B is sufficiently large and negative a high potential-energy barrier occurs at the planar ring (see Figure 2c). The eigenvalues that are below the top of the barrier occur in pairs, with the spacing between the members of each pair

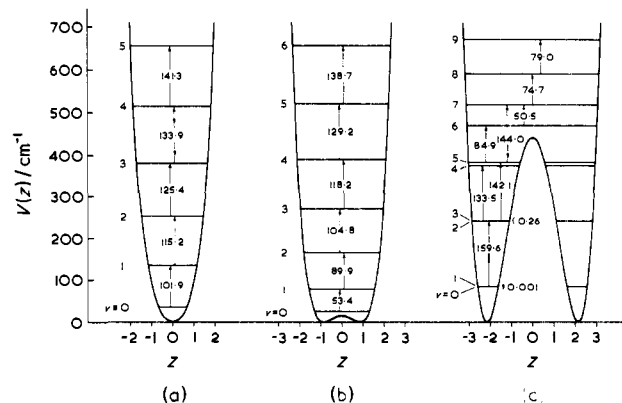

Figure 2. Reduced one-dimensional potential-energy functions $V(z) = az^4 + bz^2$ for the ring-puckering mode in (a) a molecule with a planar equilibrium conformation (positive b , oxacyclopent-3-ene (2,5-dihydrofuran), ref 28), (b) a molecule with a very low potential-energy barrier to the planar ring (small negative b , oxetane, ref 4), and (c) a molecule with a high potential-energy barrier to the planar ring (large negative b , silacyclobutane, ref 19). In each case the definition of z is that of eq 4 in ref 13. The wavenumbers of transitions between ring-puckering energy levels observed in the far-infrared spectra of the appropriate substances are also indicated.

increasing as the top of the barrier is approached. In the limit of a very high barrier, the pairs of eigenvalues become degenerate. A detailed discussion of the behavior of the vibrational eigenvalues with the evolution of the potential-energy barrier has been given by Gwinn and Gaylord.¹¹

The important conclusion from Figure 2 is that the spacing of the vibrational eigenvalues is sensitive to the nature of $V(z)$. We shall see later that this is also true of certain other spectroscopic observables associated with given vibrational eigenstates. A matter of additional importance is that at normal temperatures several quanta of the ring-puckering vibration are significantly populated because the mode is usually of low energy. Consequently, the observation of several vibrational spacings and the properties associated with several eigenstates is possible. The behavior of the vibrational eigenstates as a function of the puckering quantum number v can therefore be investigated and from this the nature of $V(z)$ diagnosed, both qualitatively and quantitatively.

Once the reduced one-dimensional potential function for a four-membered ring is known, the barrier to inversion via the planar ring is established. The values of the coordinate x at two equivalent minima are also of some interest. These can be determined from the z values at the minima if the reduced mass (μ) of the vibration is known. Sometimes μ has been obtained by using, for example, the experimentally determined potential-energy function and the variation of the rotational constants with the puckering quantum number v in order to determine the dynamical path of the vibration.¹⁶ Mostly, however, a model for the motion has been assumed in order to calculate μ , the most common being a simple curvilinear model involving no stretching of bonds and with the local symmetry of CH_2 groups, etc., preserved (i.e., no mixing of the puckering and CH_2 rocking modes).¹⁷ With sufficient knowledge of, or by making reasonable assumptions about, the molecular geometry the angle of puckering at equilibrium, α (see Figure 1a for definition), can be calculated from the x_{min} values. Some authors¹⁸ have also determined the average of α values appropriate to the extremes of the ring-puckering motion in the vibrational state in question in order to compare with values determined by other techniques.

In cases where the planar ring does not have a plane of symmetry (e.g., exocyclically monosubstituted cyclobutanes), odd-powered terms in $V(x)$ are no longer precluded by symmetry, and functions of the type

$$V(x) = Ax^4 + Bx^3 + Cx^2 \quad (5)$$

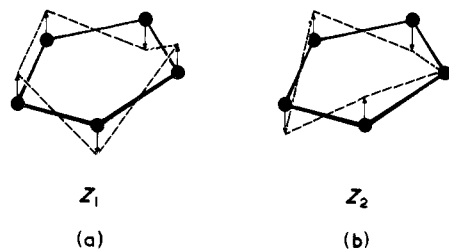

Figure 3. Out-of-plane skeletal modes (arrows) of a five-membered ring: (a) bending mode (z_1) and (b) twisting mode (z_2). The dashed lines delineate (a) the bent (C_{2v}) conformation and (b) the twisted (C_2) conformation.

have proved successful. Such functions can then have two inequivalent minima, but now the maximum no longer necessarily coincides with $x = 0$ since symmetry no longer demands it. A maximum at $x = 0$ has often been assumed, however, in order to exclude the term linear in x from $V(x)$. The form of the vibrational eigenvalues for asymmetric functions has been discussed^{19,20} with the aid again of a transformation to the reduced puckering coordinate z .

The success of the one-dimensional approximation in four-membered rings is measured by the extent to which the available experimental data are accounted for by the determined potential-energy function $V(x)$. In most cases it has proven very satisfactory, although it has been shown that for some molecules isotopic substitution leads to a slight change in the potential function. Under the one-dimensional approximation (assuming that the Born-Oppenheimer approximation is valid), the function should be isotopically invariant. The changes have been attributed, therefore, to a breakdown of the one-dimensional approximation²¹ through mixing of the puckering mode with other (mainly the CH_2 rocking) modes.

3. Two-Dimensional Approximation for Five-Membered Rings

For five-membered rings there are $n - 3 = 2$ out-of-plane skeletal ring modes consisting of a bend and a twist (see Figure 3). Both modes may be low in frequency and the one-dimensional approximation discussed above may be inappropriate. The general theory of ring puckering in five-membered rings has been discussed systematically by Gwinn and co-workers^{7,8} under the assumption that the two out-of-plane ring modes are separable from all other modes. They delineate several cases, classified according to the nature of the two-dimensional potential-energy function involved. Case 1, in which the two modes of a ring of planar equilibrium conformation are degenerate harmonic oscillators, will not be pursued here.

In case 2, the out-of-plane modes are again assumed degenerate but each is now governed by a double minimum potential function of the reduced type $V(z) = az^4 + bz^2$ ($b < 0$). The two-dimensional potential-energy surface is shown in Figure 4. It is convenient in this case to discuss the motion and solve the vibrational eigenvalue problem by using the polar coordinates r and ϕ which are defined in terms of the ring-puckering coordinates z_1 and z_2 by $z_1 = r \cos \phi$ and $z_2 = r \sin \phi$. The two modes viewed in these orthogonal coordinates consist of motion with respect to r (the radial mode) and motion with respect to ϕ (the pseudorotational mode). In Figure 4, there is a high barrier at $r = 0$ corresponding to the planar ring, but as r increases the energy passes through a minimum at the puckered ring. The radial mode, which is like a conventional vibration, is an oscillation of the amplitude of puckering about the puckered equilibrium conformation. The pseudorotational mode is less conventional. During this motion the molecule alternates between the equilibrium bent and twisted conformations, and the atom with respect to which the molecule is twisted or bent, i.e., the phase of the puckering, progresses around the

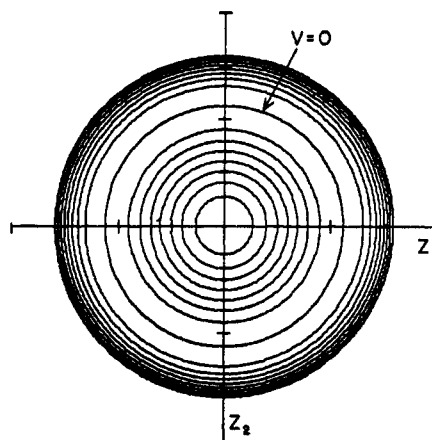

Figure 4. Two-dimensional potential-energy surface for a five-membered-ring molecule exhibiting free pseudorotation. Equipotential contours are drawn at 150-cm^{-1} intervals. See Figure 3 for definition of z_1 and z_2 and the text for discussion. (Reproduced, with permission, from ref 7. Copyright 1969, American Institute of Physics.)

ring. An important conclusion for the present purposes is that starting from a given conformation the molecule can, by means of the pseudorotational path, invert its conformation (i.e., reverse the signs of the displacements in Figure 3) without surmounting the central barrier but rather by taking the isoenergetic path along the valley round it.

Details of the pseudorotational motion and the solution of the eigenvalue problem have been discussed fully elsewhere.^{6,7,22} The results are merely summarized here. If the barrier to the planar ring is very high, if r is limited to small values (i.e., if the equilibrium extent of puckering is small), and if r remains close to the equilibrium value, the radial and pseudorotational motions are assumed separable. If only infinitesimal displacements in r from equilibrium are assumed, the radial equation becomes that of the harmonic oscillator. The eigenvalues of the pseudorotational equation are

$$E = B_v m^2 \quad (6)$$

(where $m = 0, \pm 1, \pm 2, \dots$ and $B_v = (\hbar/4\pi) \langle 1/r^2 \rangle_w$), which are like those of an effective rigid planar rotor of rotational constant B_v . Essentially free pseudorotation of this kind has been inferred for cyclopentane,⁶ for which the planar conformation has D_{5h} symmetry. If the potential energy along the pseudorotational coordinate ϕ is given in the usual way by

$$V(\phi) = \frac{1}{2} \sum_n V_n (1 - \cos n\phi) \quad (7)$$

the first term allowed by symmetry would be that with coefficient V_{10} , which is expected to be extremely small. Hence, an effectively zero barrier is presented to the motion. The small value $B_0 \approx 3 \text{ cm}^{-1}$ in cyclopentane⁶ results in a high density of doubly degenerate, low-lying pseudorotational levels increasing in energy as m^2 . One consequence of this is a higher calorimetric entropy than otherwise expected, as a result of which pseudorotation was indeed first postulated.⁶ The radial and pseudorotational energy levels also give rise to spectroscopic consequences from which details of the potential-energy surface (shown in Figure 4) can be derived.

The case 3 proposed by Gwinn et al.⁷ refers to hindered pseudorotation. Both modes are still governed by a double-minimum potential-energy function, but these are no longer identical, although nearly so. The potential surface (shown in Figure 5) is like that of case 2 except that the phase of the puckering does not make unhindered, isoenergetic progress around the ring, but the pseudorotational path encounters maxima and minima in energy in the valley around the central maximum. This case also has been treated in the approximation

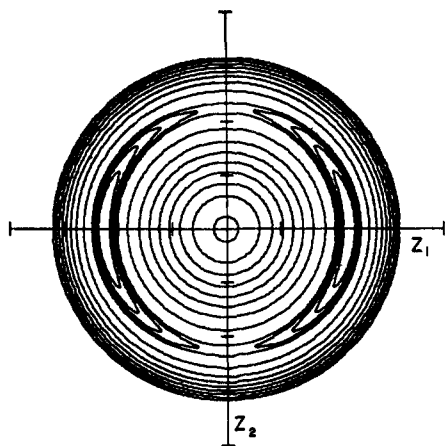

Figure 5. Two-dimensional potential-energy surface for a five-membered-ring molecule having a small barrier to pseudorotation at $\phi = \pi/2$ and $3\pi/2$. The first five potential-energy contours are spaced at intervals of 10 cm^{-1} and the remainder at 150-cm^{-1} intervals. See Figure 3 for definition of z_1 and z_2 and the text for the definition of ϕ . (Reproduced, with permission, from ref 7. Copyright 1969, American Institute of Physics.)

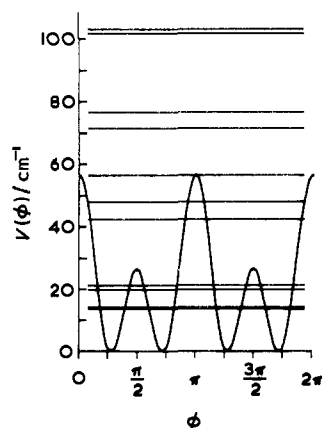

Figure 6. Variation of potential energy $V(\phi)$ with pseudorotational coordinate ϕ in the ground state of the radial mode of oxacyclopentane. The complicated pattern of pseudorotational energy levels in this case of a low barrier to pseudorotation is also illustrated. (Redrawn from ref 8.)

of separability of the radial and pseudorotational modes, with the potential energy along the valley given by

$$V(\phi) = \frac{1}{2}V_2(1 - \cos 2\phi) + \frac{1}{2}V_4(1 - \cos 4\phi) + \dots \quad (8)$$

where the coefficients V_2, V_4, \dots are average values for a given radial state.⁸ The effect of the presence of the small barrier to pseudorotation is to remove the $\pm m$ degeneracy of the zero-barrier case and complicate the pattern of low-lying pseudorotational energy levels. Figure 6 shows $V(\phi)$ determined for oxacyclopentane (tetrahydrofuran)⁸ in the ground state of the radial mode together with some of the pseudorotational energy levels.

The solutions for the radial and pseudorotational energy levels in cases 2 and 3 under conditions in which the central barrier is assumed to be finite have been investigated by two groups.^{23,24} The two motions cannot now be factored. The essential conclusions, which are borne out by experiment, are that (i) E_m is no longer a linear function of m^2 but for a given radial state the function shows negative curvature, (ii) B_v increases with the radial quantum number ν , and (iii) the radial mode shows negative anharmonicity. It is clear, therefore, that quantities determined spectroscopically by using the factored approximation will be subject to some error. The importance of the unfactored two-dimensional treatment in the present context is that, given

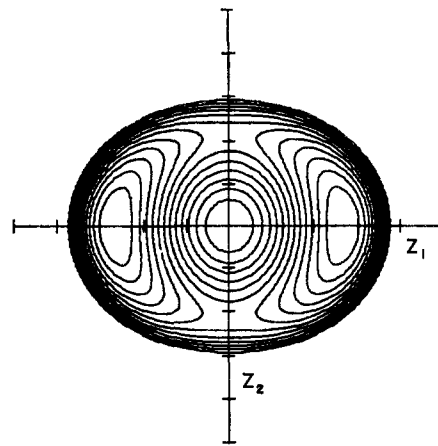

Figure 7. Two-dimensional potential-energy surface for a five-membered-ring molecule having a high barrier to pseudorotation at $\phi = \pi/2$ and $3\pi/2$. Equipotential contours are drawn at 150-cm^{-1} intervals. See Figure 3 for definition of z_1 and z_2 and the text for the definition of ϕ . (Reproduced, with permission from ref 7. Copyright 1969, American Institute of Physics.)

pseudorotational spacings and at least one of the radial-mode energy spacings, it can be used to fit a two-dimensional potential surface having a finite barrier to planarity to the observed data.²⁵ The barrier to the planar ring is inaccessible in the factored approximation.

The final class of two-dimensional potential functions to be considered here is that in which the barrier to pseudorotation is large (case 4 of Gwinn et al.).⁷ The form of the potential-energy surface is then as shown in Figure 7. If z_1 is identified with the ring-bending coordinate and z_2 with the twisting coordinate, the case illustrated is that of a molecule with a stable bent conformation about which it can execute twisting and bending vibrations, with the former lower in frequency. The alternative assignment of z_1 and z_2 is also possible, but then the twisted conformation is the more stable. In molecules like cyclopentene which have an endocyclic double bond, the barrier to pseudorotation is greater than the barrier to the planar ring because the energy required to twist the double bond and produce the twisted (C_2) conformation is high. Then the two vibrations are the bending mode z_1 , governed by a double minimum function, and the twisting mode z_2 , which is controlled by a single minimum function. Since the latter mode usually has much higher energy, the former resembles that of a four-membered ring (see Figure 1b for a definition of the corresponding ring-puckering coordinate x). For this reason five-membered rings with an endocyclic double bond have been termed pseudo-four-membered by Laane and Lord.¹² Some molecules, like oxacyclopent-3-ene (2,5-dihydrofuran), have no central barrier, in which case the two modes are both governed by a single minimum function. A critical examination of the one- and two-dimensional approximation in this case has been made by Carreira, Mills, and Person.²⁶

III. Experimental Determination of Ring Conformation and Geometry

A. Introduction

In the preceding section, we have seen that the vibrational eigenvalues associated with the puckering modes of four- and five-membered rings are sensitive to the nature of the potential-energy functions governing the modes. This is also true for those quantities associated with different states of the modes that can be derived from rotational spectroscopy, discussion of which was postponed until this section for convenience. If energy-level spacings and vibration-rotation interaction parameters can be determined experimentally, it is possible to use them

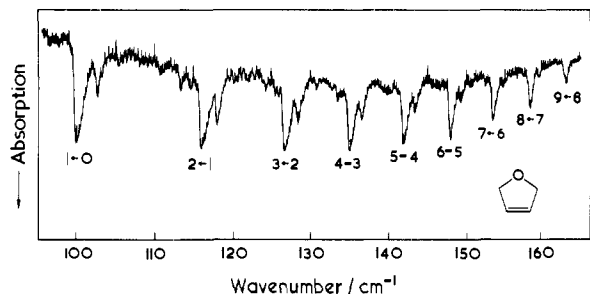

Figure 8. Far-infrared spectrum of gaseous oxacyclopent-3-ene (2,5-dihydrofuran) (30-cm path, pressure 60 torr) showing $\nu + 1 \leftarrow \nu$ transitions in the ring-puckering mode. The corresponding reduced one-dimensional potential-energy function for the ring-puckering mode is shown in Figure 2a. The satellites arise from the same progression but in the state $\nu_T = 1$ of the ring-twisting mode. (Redrawn from ref 28.)

to infer the form of the function in question, both qualitatively and quantitatively. In principle, the whole of the potential-energy surface could be mapped, but the experimental data available so far are inadequate, and the approximations alluded to previously have been used.

The most powerful methods of obtaining the required experimental data are spectroscopic.^{11,14,22} In the following, the means of determination of vibrational spacings by far-infrared, infrared, and Raman spectroscopy are outlined but without any review of experimental methods. Some typical spectra obtained by the first method will be illustrated, and the form of the potential-energy functions derived from them in the above-mentioned approximations will be given. An outline of the use of rotational spectroscopy to give vibration-rotation interaction parameters and the inference from these of potential functions are also presented. The detailed geometrical structures of rings, knowledge of which can supplement that of the conformation determined by the above methods, have been elucidated by both rotational-spectroscopic and electron-diffraction techniques. The various types of geometrical parameters that can be so derived are discussed.

B. Vibrational Spectroscopy

1. Far-Infrared Spectroscopy

a. Four- and Pseudo-Four-Membered Rings

The most widely used route to vibrational spacings in the puckering mode for four- and pseudo-four-membered rings is through far-infrared spectroscopy. When these modes are governed by very anharmonic potential-energy functions, not unexpectedly the $\Delta\nu = 1$ selection rule breaks down and $\Delta\nu = 2$ and 3 transitions can become quite strongly allowed.

If the ring-puckering mode is infrared active, $\nu + 1 \leftarrow \nu$ transitions are most commonly observed, usually in the wavenumber range 30–200 cm^{-1} . The hot bands ($\nu > 1$) often have significant intensity because of the high Boltzmann population of excited states of this low-energy mode. For most molecules investigated each $\nu + 1 \leftarrow \nu$ transition has a P, Q, and R branch structure with a sharp and prominent Q branch. Rotational fine structure is rarely apparent. The main feature of the far-infrared spectrum, if the anharmonicity of the mode is sufficient, consists of a series of sharp Q branches superimposed on a broad background formed by overlapping P and R branches of the several $\nu + 1 \leftarrow \nu$ transitions. If the Q-branch maximum is interpreted as the vibrational band origin,²⁷ values of the vibrational spacing accurate to 0.1 cm^{-1} can be obtained.

Some typical far-infrared spectra are shown in Figures 8–10. When the one-dimensional potential-energy function is of the type shown in Figure 2a, for example in oxacyclopent-3-ene,²⁸ the Q branches progress smoothly to high frequency (see Figure

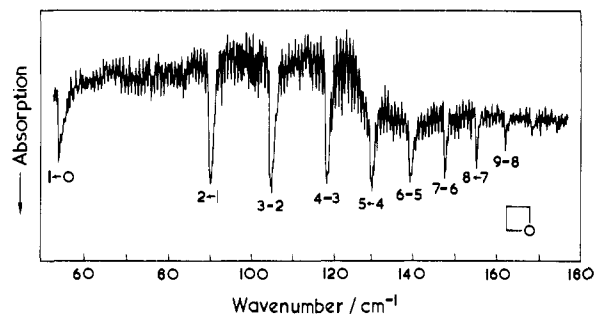

Figure 9. Far-infrared spectrum of gaseous oxetane (1-m path, pressure 48 torr) showing $\nu + 1 \leftarrow \nu$ transitions in the ring-puckering mode. The corresponding reduced one-dimensional potential-energy function for the ring-puckering mode is shown in Figure 2b. (Redrawn from ref 29.)

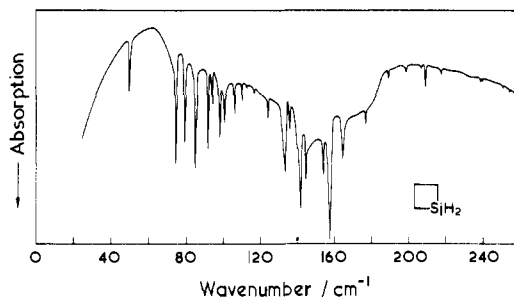

Figure 10. Far-infrared spectrum of gaseous silacyclobutane (path 8 m, pressure 60 torr) showing the complicated pattern of transitions associated with the ring-puckering mode. The corresponding one-dimensional potential-energy function for the ring-puckering mode is shown in Figure 2c. (Redrawn from ref 19.)

8) as a result of the divergent spacings associated with a significantly quartic function. The introduction of a very small barrier, as in Figure 2b, leads to a slightly irregular spacing of the Q branches, as seen in Figure 9 for oxetane.²⁹ A higher barrier case (Figure 2c) is characterized by a very irregular pattern of Q-branch positions and intensities, as for silacyclobutane¹⁹ in Figure 10, and assignment can be a difficult problem. In such cases, evidence about the function gained from vibration-rotation effects in the rotational spectrum is useful, particularly if transition intensities in the far-infrared can be calculated.^{18,30}

Once the vibrational spacings have been measured, a one-dimensional reduced potential function $V(z) = az^4 + bz^2$ is usually fitted to the data, leading immediately to the height of the energy barrier to the planar ring (or to that presented to the stable conformer if the planar ring has no plane of symmetry). Calculation of the vibrational reduced mass from a model or its knowledge from the experimentally established dynamics of the motion allows the unreduced coordinate x to be obtained from z , which in turn leads to the angle of puckering α (see Figure 1).

b. Saturated Five-Membered Rings

The far-infrared spectra of saturated five-membered rings are often complicated by the presence of pseudorotation in the molecule, the extent of the complexity depending on the barrier presented to the motion. Indeed, the electric dipole selection rules³¹ for transitions involving pseudorotational and radial eigenstates allow the following transition types in cyclopentane-like molecules: (i) pure pseudorotational transitions in a given radial state ($\Delta m = \pm 1$, $\Delta\nu_r = 0$, overtones $\Delta m = \pm 2$, $\Delta\nu_r = 0$); (ii) pure radial transitions ($\Delta\nu_r = 1$, $m = 0$); and (iii) pseudorotational and radial transitions in combination ($\Delta\nu_r = 1$, $\Delta m = 0, \pm 1, \pm 2 \dots$). In addition, for a nonzero pseudorotational barrier the restrictions $+\leftrightarrow +$ and $-\leftrightarrow -$ must be applied to m if the $\pm m$ degeneracy is lifted.

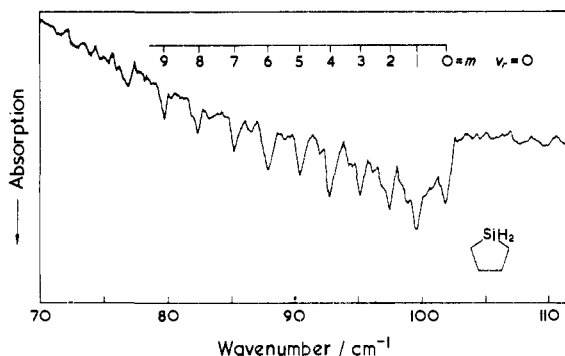

Figure 11. Far-infrared spectrum of gaseous silacyclopentane (path 40 m, pressure 5 torr) showing the $m + 1 \leftarrow m$ progression of pseudorotational transitions in the ground state of the radial mode ($\nu_r = 0$). (Redrawn from ref 34.)

Transitions of type i are so far undetected for molecules with no pseudorotational barrier, although $\Delta m = \pm 1$ transitions in combination with the CH_2 deformation fundamental have been observed for cyclopentane.³² Type iii transitions have recently been reported also for cyclopentane.³³ Molecules having very small barriers to pseudorotation, e.g., oxacyclopentane (tetrahydrofuran), exhibit far-infrared spectra complicated by the lifting of the $\pm m$ degeneracy, although well above the barrier the pattern expected of a free pseudorotator obtains.³¹ The interpretation of the spectral region containing transitions originating in levels near the barrier can be greatly facilitated if the small splittings in that region are known through vibration-rotation interaction effects in the microwave spectrum.^{6,31} The potential-energy function shown in Figure 6 was derived with the aid of such data by fitting vibrational spacings with a function like that of eq 8 in a one-dimensional angular Schrödinger equation.

As the barrier to pseudorotation becomes large, the $\pm m$ degeneracy is reinstated (except close to the top) and the type i spectrum becomes regular. Figure 11 shows the $\Delta m = \pm 1$, $\nu_r = 0$, Q-branch transitions for silacyclopentane,³⁴ the progression in m beginning at 101.7 cm^{-1} . A similar progression in the $\nu_r = 1$ state is apparent also. A one-dimensional treatment using eq 8 truncated after the V_2 term allowed Laane³⁴ to fit the $\nu_r = 0$ progression satisfactorily. This function (shown in Figure 12) has minima at $\phi = \frac{1}{2}\pi$ and $\frac{3}{2}\pi$ corresponding to the C_2 , half-chair, form of the molecule, whereas the maxima at $\phi = 0$ and π define the C_s bent conformer (see Figure 3). The barrier to pseudorotation of $1362 \pm 25 \text{ cm}^{-1}$ is high and led to speculation³⁵ about the validity of the separation of the angular and radial wave equations. Durig, Natter, and Kalasinsky³⁵ determined the separations $\nu_r + 1 \leftarrow \nu_r$ for $\nu_r = 0, 1, 2$ in the Raman spectrum and then used them with Laane's $\Delta m = \pm 1$, $\nu_r = 0$, data in a two-dimensional treatment of the out-of-plane ring vibrations in which the angular and radial motions were not factored. The potential-energy surface so

$$V(r, \phi) = Ar^4 + Br^2 + Cr^2 \cos 2\phi + Dr^4 \cos 2\phi + Er^2 \cos 4\phi \quad (9)$$

determined has barriers of 1559 and 1414 cm^{-1} to the planar ring and pseudorotation, respectively, as measured from the more stable C_2 form. In this case, the second of these differs little from that obtained in the one-dimensional analysis.

2. Infrared Spectroscopy

Ueda and Shimanouchi³⁶ and Durig et al.³⁷ observed that the fundamentals of modes involving CH_2 groups in a number of molecules exhibited progressions of Q branches to both high and low wavenumber. These were attributed to combination (sum and difference) bands of the fundamental with the ring-puckering mode of the molecule in question. The $\nu + 1 \leftarrow \nu$ separations of the puckering mode derived from such combi-

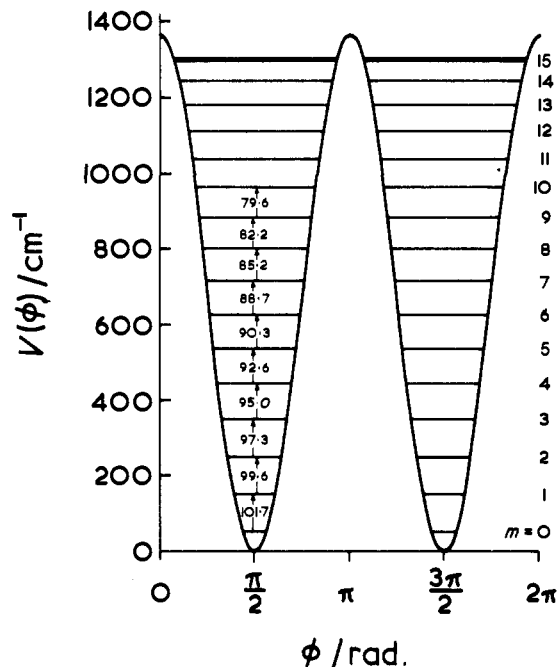

Figure 12. One-dimensional potential energy $V(\phi)$ as a function of the pseudorotational coordinate ϕ for the $\nu_r = 0$ state of silacyclopentane as derived from the $m + 1 \leftarrow m$ progression of pseudorotational transitions shown in Figure 11. The pseudorotational eigenvalues and $m + 1 \leftarrow m$ transition wavenumbers are indicated. (Redrawn from ref 34.)

nation bands are often in good agreement with those observed directly in the far-infrared spectrum, when the latter are known. The separations so determined can be used in the manner discussed above to infer the form of the puckering potential function.

This approach is particularly valuable in cases like cyclobutane,³⁸ where the ring-puckering mode is infrared inactive, or methylenecyclobutane,³⁹ where the far-infrared spectrum presents difficulties, or cyclopentane, for which pseudorotational transitions have been observed only in combination bands involving the CH_2 deformation mode.³² The use of combination bands is not without difficulties, however, and the derived separations should be treated cautiously. A careful comparison of puckering-mode separations from far-infrared spectroscopy and mid-infrared combination bands shows that those from the latter can be significantly in error, especially when the higher wavenumber CH_2 modes are involved in the reference band.^{40,41}

3. Raman Spectroscopy

The recent renaissance of Raman spectroscopy initiated by the advent of high-powered lasers has led to extensive investigation of ring-puckering modes by this technique. The selection rule $\Delta \nu = 2$ appears to be obeyed in most cases, even for molecules with highly anharmonic potential functions, such as thietane.⁴² The Raman technique is particularly useful in those cases where far-infrared spectroscopy is inapplicable or particularly difficult. Cyclobutane^{43,44} and cyclopentane²⁵ fall into the first category, with the ring-puckering modes infrared inactive, while methylenecyclobutane⁴⁵ is an example of the second type. Combination bands involving the ring-puckering mode have also been observed in the Raman spectrum.^{46,47}

C. Rotational Spectroscopy

1. Effective Rigid-Rotor Approximation

The rotational spectrum of a ring molecule is replete with information about the ring conformation. The usually low-lying nature of ring-puckering modes ensures that at normal tem-

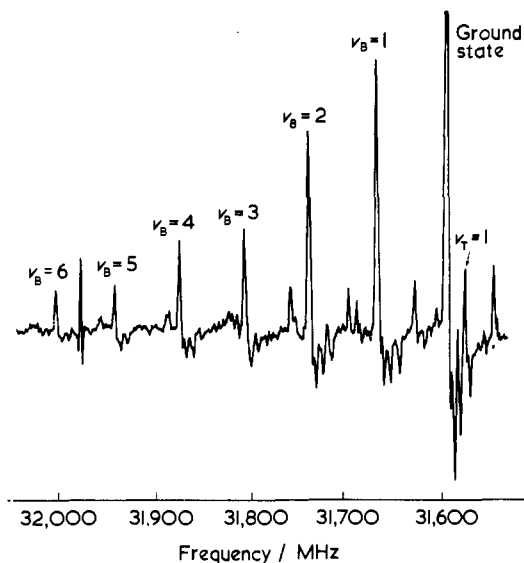

Figure 13. The $5_{3,2} \leftarrow 4_{3,1}$ rotational transition of cyclopent-3-ene in the vibrational ground state and in successive excited states (v_B) of the ring-bending mode.

peratures a number of their excited states have an appreciable Boltzmann population and hence that the rotational spectra in several such states can be observed. Figure 13 shows as an example a particular rotational transition in the ground state and in several excited states associated with the ring-bending (puckering) and ring-twisting modes of the pseudo-four-membered ring cyclopent-3-ene.⁴⁸ Except in the special circumstances (see below) when a vibrational separation in a puckering mode is of the same order as a rotational spacing,¹⁶ the effective rigid-rotor approximation applies to such spectra. Thus, analysis of the rotational spectrum of a molecule in a given vibrational state v leads to effective rotational constants B_v (used as a general symbol for A_v , B_v , and C_v here) and to the effective principal moments of inertia I_b^v . The equilibrium conformation and details of the ring-puckering potential-energy function can be inferred from these quantities in several ways.

a. Form of the Ring-Puckering Potential-Energy Function

Gwinn and co-workers^{2,16} have shown that the variation of B_v with the ring-puckering quantum number v can be expressed as a power series expansion in expectation values of the reduced puckering coordinate z according to

$$B_v = \beta_0 + \beta_1 \langle z^2 \rangle_{v,v} + \beta_2 \langle z^4 \rangle_{v,v} + \dots \quad (10)$$

if the planar ring has a plane of symmetry and if no vibrational separation is of the same order as a rotational separation. The coefficients β_n in eq 10, which is usually truncated after the fourth power term, can either be treated as empirical parameters or can be calculated from a dynamical model of the puckering motion. The effect on the vibrational wave functions for the puckering mode of introducing a barrier into a single-minimum potential energy function is to perturb the states of even and odd v differentially. This perturbation is transmitted to the $\langle z^n \rangle_{v,v}$ values and hence to B_v through the wavefunctions. The result as the barrier height is increased from zero is that a zigzag behavior is induced in B_v as a function of v . The effect is illustrated in Figure 14 in which $C_v - C_0$ is shown as a function of v for cyclopent-3-ene,⁴⁸ oxetane,² and cyclopentene.⁴⁹ The barriers to the planar ring in these molecules are 0, 15, and 232 cm^{-1} , respectively. In the case of cyclopentene, the C_v values for $v = 0$ and 1 have been first corrected for the effects of a Coriolis perturbation of the type discussed below.⁴⁹

The smooth variation of C_v with v in cyclopent-3-ene is indicative of a planar ring skeleton at equilibrium. It has been

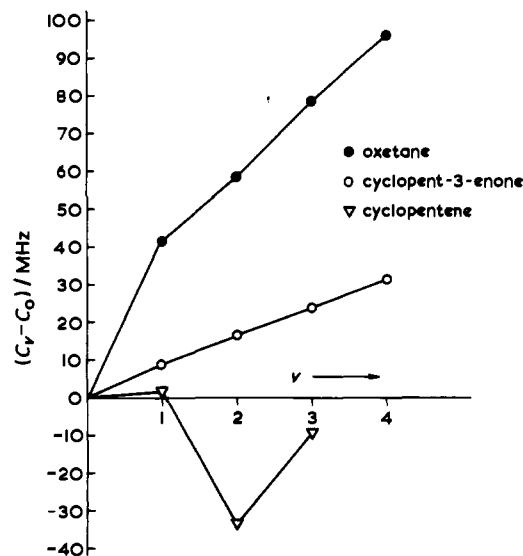

Figure 14. Variation of the rotational constant C_v with the ring-puckering quantum number v for cyclopent-3-ene, oxetane, and cyclopentene. The potential-energy functions governing the ring-puckering modes are of the types shown in Figure 2a, 2b, and 2c, respectively.

pointed out that a linear dependence of a rotational constant on v is characteristic of harmonic-oscillator behavior while a quartic term in the potential-energy function $V(z) = az^4 + bz^2$ governing the ring mode contributes a smooth negative curvature.² In oxetane, the zigzag behavior is obvious even though the top of the barrier is lower than the zero-point vibrational level. When the levels $v = 0$ to 4 fall beneath the maximum of the function, the zigzag behavior is even more pronounced, as for cyclopentene. A detailed account of these effects is given in ref 11.

The variation of B_v with v is not only of qualitative significance, however, in diagnosing the nature of $V(z)$. If the coefficients β_n are treated as empirical parameters, it is possible to find by a least-squares procedure the function $V(z)$ which leads to $\langle z^n \rangle_{v,v}$ values in best agreement with observation when the latter are used in eq 10. A double-minimum potential-energy function was derived by this means for the first molecule shown to possess a low barrier to the planar ring (oxetane),² and indeed the somewhat similar behavior of the centrifugal distortion constants with v has likewise been used.^{50,51} Although the foregoing has been illustrated by reference to four- and pseudo-four-membered rings, the same considerations are applicable to saturated five-membered rings.⁸

According to Figure 14, the ring-bending mode in cyclopent-3-ene is of the single-minimum type, and hence a smooth variation in vibrational spacing with v is expected. Examination of Figure 13 unexpectedly reveals an irregular behavior in the intensity of the vibrational satellites with v which is caused by the superposition of nuclear-spin statistical weight effects on the otherwise smooth change of intensity predicted. Planar cyclopent-3-ene has C_{2v} symmetry, so that the operation C_2 exchanges three pairs of equivalent protons. For compliance with the requirement that the total wave function is antisymmetric in this respect, states of even v for the rotational transition illustrated have a nuclear-spin statistical weight of 9 while those of odd v have a weight of 7, given that the puckering mode belongs to the species B_1 . The extra intensity in satellites of even v is clear confirmation of the symmetry of the vibration. Moreover, the presence of such nuclear-spin statistical weight effects means that the barrier to the planar ring is not so high that states have become degenerate in pairs.

After correction for any effects arising from nuclear-spin statistical weights, the relative intensities of transitions along the satellite series of Figure 13 lead to the population of the levels

(if the electric dipole moment as a function of v is known or assumed) and hence through the Boltzmann factor to the vibrational separations.⁵² This technique can be useful in cases where the latter are not otherwise available, but some care should be taken, for the measurement of relative intensities in the microwave region is fraught with difficulties.⁵²

b. Detailed Molecular Geometry

Once it is established whether the equilibrium conformation of a ring is planar or puckered, it is possible to use effective ground-state moments of inertia, I_b^0 , to determine the detailed geometry. In principle, it is possible to determine the equilibrium geometry (r_e), but sufficient data are as yet available in the case of no ring. In practice, two types of molecular geometry, both pertaining to the zero-point state, have been used in place of r_e .

When a sufficient number of isotopic species have been studied that the minimum number of I_b^0 values is available to allow the molecular geometry to be fitted to the first and second moment conditions as if the I_b^0 were equilibrium values, the resulting geometry is said to be of the r_0 type.⁵³ When this is overdetermined by using each of several minimal sets of isotopic data in turn, bond lengths, for example, can differ by ~ 0.01 Å from set to set. Such isotopic variations of r_0 geometry are inherent in its definition, for the I_b are not equilibrium values but are averaged over the zero-point vibration, which changes on isotopic substitution. Even in the simplest case of a diatomic molecule $r_0 = \langle r^{-2} \rangle^{-1/2}$. In effect, a slightly different r_0 geometry obtains for each isotopic species.

In an attempt to define a molecular geometry which is both isotopically invariant and experimentally attainable, Costain⁵⁴ has suggested that each atom is isotopically substituted in turn and that its so-called r_s coordinate in the principal axis system of the parent species is determined by using I_b^0 values in Kraitchman's equations.⁵⁵ Although these equations are rigorously true only when equilibrium moments of inertia are used, it is assumed that in using I_b^0 the zero-point effects will cancel to some extent since the coordinates depend (to first order) only on changes in moments of inertia on isotopic substitution. Indeed, Watson⁵⁶ has shown that, if the quantity I_b^s is calculated by using the r_s coordinates of all atoms in the appropriate second moment equation, then I_b^s is the mean of I_b^0 and I_b^e . When overdetermined, r_s geometries are essentially isotopically invariant and have the physical significance recently discussed by Watson.⁵⁶

Although it is usual to assume that r_0 and r_s geometries approximate to r_e , it is important to point out that, depending as they do on effective moments of inertia, they should be treated cautiously in the case of molecules having very large amplitude vibrations and highly anharmonic potential functions.

2. Non-Rigid-Rotor Behavior

The effective rigid-rotor approximation is not always applicable to ring molecules. Occasionally certain transitions deviate considerably from the expected pattern. A detailed analysis shows that this occurs in molecules for which a vibrational spacing in the ring-puckering mode is of the same order as a rotational spacing.^{2,16} Cyclopentene^{49,57} is one such molecule, with a $v = 1 \leftarrow 0$ separation of 0.91 cm^{-1} .

It has been shown^{16,57} that the effective rotational Hamiltonian in each of the vibrational states in question is like that of the effective rigid rotor except that it carries a Coriolis term of the type $FP_v P_\alpha / I_\alpha$, where P_v is the vibrational angular momentum arising from the ring-puckering motion and P_α is the rotational angular momentum along the principal inertial axis $\alpha = a, b$, or c . The effect of this term is to couple pairs of rotational states associated with different ring-puckering quantum numbers. The resulting interaction of the pair of states is usually undetectable,

even by microwave spectroscopy, unless the vibrational separation $\Delta E/h$ is ~ 1 GHz or less.¹¹ Then large, readily detectable perturbations from rigid rotor behavior occur for states so linked. As J and v increase, nonnegligible interactions set in for larger ΔE values.

If the perturbed rotational spectrum in the two vibrational states can be assigned (not normally a trivial exercise), it is possible to fit the two spectra by using an effective rotational Hamiltonian for each state which includes the Coriolis term. This can be done by diagonalizing the entire energy matrix for both vibrational states and using an iterative least-squares procedure to fit ΔE , F , and the effective rotational constants for each state. Vibrational separations of microwave accuracy have been obtained in this way^{16,57} and have been used as data from which to determine the ring-puckering potential function.

In some cases not only are pure rotational transitions in each of the two puckering states observed but transitions involving changes in the vibrational quantum number also occur in the microwave region.¹⁸ These too serve as useful data for the determination of ΔE .

D. Electron Diffraction

1. Geometrical Parameters r_a , r_g , r_α , and r_α^0

The technique of electron diffraction by gases has been applied to determine the detailed molecular geometry of a number of small-ring compounds. The theory and experimental methods have been reviewed extensively⁵⁹ and will not be discussed here. Our attention is restricted to a brief definition of the types of geometrical parameters that can be derived by this technique.^{60,61}

The quantity determined from the electron-diffraction experiment on a gas is essentially the molecular contribution to the intensity of scattered electrons as a function of scattering angle. Such intensity curves can be related via a Fourier transform to the radial probability distribution function $P(r)/r$. As normally determined, $P(r)/r$ consists of a set of essentially Gaussian peaks, the center of gravity of each of which, in principle, corresponds to a given internuclear distance r_{ij} in the molecule and the half-width of each which depends on the mean-square amplitude of vibration l_{ij} for the pair of atoms along the internuclear line.

Given the $P(r)/r$ curve, it is possible by choosing a trial model of the molecular geometry and dynamics and using a suitable least-squares-adjustment procedure to find the set of r_{ij} and l_{ij} which best reproduces the curve.

Alternatively, a set of l_{ij} obtained by spectroscopic means can be put into the calculation. The internuclear distances r_{ij} determined in this most direct manner from experiment are called r_a values.

Once the l_{ij} are known, a quantity designated r_g can be defined by

$$r_g = r_a + l^2/r_e \quad (11)$$

and corresponds to the instantaneous internuclear distance in question averaged, with due regard to the Boltzmann distribution, over all molecular vibrations at the given temperature. It is usually assumed that r_a can be used in eq 11 in place of r_e to a good approximation.

A problem with r_g values concerns the so-called shrinkage effect. In linear molecules XYX, for example, it is found that $r_g(X \cdots X) < 2r_g(X-Y)$ and consequently that angle XYX $< 180^\circ$. In the case of CO₂, the angle OCO = 172.27° is obtained in this way.⁶² The reason for this problem is that on average molecules have a bent conformation so that the nonbonded distance is shorter than in the linear molecule. This effect can clearly be serious for four- and five-membered-ring molecules having low-energy large-amplitude ring-puckering vibrations if

the dihedral angle of puckering is to be obtained from electron-diffraction data. In order to circumvent problems arising from the shrinkage effect, the r_α parameter has been defined. This is the distance between the mean positions of the atoms at the given temperature and can be determined from the corresponding r_g value with the aid of a harmonic force field for the molecule in question. By means of suitable extrapolation to $T = 0$, the corresponding quantity referred to the zero-point state r_α^0 can be obtained. This quantity is identical with the r_z parameter which can be determined from effective ground-state rotational constants by using a harmonic force field.

2. Comparison of Geometries from Spectroscopy and Electron Diffraction

The interrelationships of the various geometrical parameters determined by spectroscopy and electron diffraction have been critically reviewed by Cyvin and Kuchitsu⁶⁰ and by Robiette.⁶¹ Usually for four- and five-membered-ring compounds r_0 , r_s , r_a , or r_g structures are available. It is well-known that internal inconsistencies of ~ 0.01 Å are not uncommon in r_0 structures and Kuchitsu⁶³ has indicated that differences of more than 0.01 Å can occur between r_s and r_g versions of the same quantity. Clearly some care is necessary in comparing different types of quantities among molecules. In particular, the possibility of shrinkage effects in r_g values for ring-puckering dihedral angles must be considered. The preferable electron-diffraction quantities in this context are r_α or r_α^0 or the type r_{av} (very close to r_α^0 and r_z) recently derived by Kuchitsu and co-workers⁵⁴ for thietane by using electron-diffraction data and rotational constants in combination.

IV. Factors Controlling Conformation in Four- and Five-Membered Rings

A. Introduction

Once the equilibrium conformation and other details of the ring-puckering potential-energy function for a four- or five-membered ring have been determined experimentally as outlined in section III, it is possible to discuss the origin of the potential function in terms of the classical valence forces at play in the molecule. In this way, the factors controlling ring conformation can be elucidated.

In such discussions, the variation of the potential energy with ring-puckering coordinates has been assumed³ to arise solely from contributions from deformation of the ring angles, V_d , and from the torsional motion about ring bonds, V_t , so that

$$V = V_d + V_t \quad (12)$$

Gwinn and co-workers^{3,7,16} used terms of the $\sum_{\text{angles}} \frac{1}{2}k(\Delta\theta)^2$ for V_d and $\sum_{\text{bonds}} \frac{1}{2}V_3(1 - \cos 3\tau)$ for V_t , where V_3 's are the torsional barriers about the ring bonds, the τ 's are torsional angles measured from the planar ring, the k 's are angle-bending force constants, and the $\Delta\theta$'s are measures of the deviations of ring angles from equilibrium. By expanding the $\Delta\theta$'s and τ 's in terms of the ring-puckering coordinates, it has been possible to reproduce satisfactorily the potential-energy functions for oxetane, thietane, and oxacyclopentane.

In the following paragraphs, V_d and V_t , as defined above in terms of valence forces, are discussed in turn. The treatment here follows that of Laane^{65,66} who gives explicitly the details of the expansion of V_d and V_t in the ring-puckering coordinate x . In this way, it can be readily seen how the terms x^2 and x^4 in the potential function of the type $V(x) = Ax^4 + Bx^2$ originate. Since such a function has been very successful experimentally in dealing with four- and pseudo-four-membered rings, this will allow some insight into the origins of the experimental conformations. Moreover, the qualitative conclusions

about the latter are applicable to saturated five-membered rings, for which a similar discussion is more difficult to formulate explicitly.

B. V_d and Ring Angle Strain

In four- and pseudo-four-membered-ring molecules and to a lesser extent in saturated five-membered rings, the internal ring angles are generally smaller than the corresponding angles in analogous open-chain compounds. Thus, even in the planar ring, these angles are already strained. To account for this Laane⁶⁵ writes V_d in a slightly different form from that used by Gwinn et al.^{3,7,16}

$$V_d = \frac{1}{2} \sum_i k_i (s_i - \Delta\alpha_i)^2 \quad (13)$$

where $s_i = \alpha_i(\text{free}) - \alpha_i(\text{planar})$ and is the angle strain inherent in the planar ring while $\Delta\alpha_i = \alpha_i - \alpha_i(\text{planar})$ and is the change of the ring angle accompanying puckering. If $\Delta\alpha_i$ is expanded in a power series in x and the expansion truncated after the first term, we have

$$\Delta\alpha_i = -c_i x^2 \quad (14)$$

in which c_i is a positive constant. Substitution of eq 14 into eq 13 leads to

$$V_d = \frac{1}{2} \sum_i (k_i s_i^2 + 2k_i s_i c_i x^2 + k_i c_i^2 x^4) = A_d x^4 + B_d x^2 \quad (15)$$

The second equality in eq 15 ignores the first term in the sum which merely shifts the origin of V_d .

Equation 15 indicates that ring angle deformation contributes a positive quartic term in x to $V(x)$ while the sign of the coefficient of x^2 depends on the sign of s_i . In the case of most angles in known four- and pseudo-four-membered rings, s_i is positive and thus so is the coefficient of x^2 . Accordingly, the puckering of such rings, which means an increase in x , will increase V_d . The further ring angle strain which accompanies deformation thus favors the planar ring in this category. Moreover, the coefficient of the term quadratic in x varies linearly with s_i so that highly strained rings should have significant quadratic contributions to $V(x)$ from this source.

C. V_t and Torsional Forces about Ring Bonds

The torsional potential energy V_t^i for each single bond i in a ring can be expressed^{65,66} as

$$V_t^i = \frac{1}{2} \sum_n V_n^i (1 + \cos n\tau_i) \quad (16)$$

If the torsional angle τ_i is expressed as a power series in x ($\tau_i = 0$ at $x = 0$) and the series terminated after the first term, we have

$$\tau_i \approx h_i x \quad (17)$$

Expansion of the trigonometric function in eq 16 in powers of $n\tau_i$ followed by substitution of eq 17 and neglect of terms beyond x^4 gives





$$V_t^i \approx -(9h_i V_3^i / 4)x^2 + (27h_i^4 V_3^i / 16)x^4 = B_t^i x^2 + A_t^i x^4 \quad (18)$$

In deriving eq 18, contributions from all terms in the sum of eq 16 except $n = 3$ are ignored (as is usually the case in open-chain analogues) and terms that are independent of x and merely shift the origin of the potential energy are omitted. The sum over all bonds i gives

$$V_t = A_t x^4 + B_t x^2 \quad (19)$$

Thus, torsional forces about ring bonds contribute terms in both x^2 and x^4 to V_t and hence to $V(x)$. The sign and magnitude of A_t and B_t will depend on those of the individual V_3^i which

TABLE I

main class				subclasses				
ring type		parent molecule	class location	ring type		location		tables
<i>n</i>	<i>d</i>			<i>t</i>	<i>m</i>	<i>t</i>	<i>m</i>	
4	0, 1, 2		B	0	4, 3, 2	B.1	a, b, c	II, III
				1	3, 2, 1	B.2	a, b, c	IV
				2	2, 1	B.3	a, b	V
				4	0	B.4		VI
5	0		C	0	5, 4, 3, 2	C.1	a, b, c, d	IX, X
				1	4, 3, 2	C.2	a, b	XI
				2	2	C.3		XI
5	1		D	2	3, 2	D.1	a, b	XII, XIII
				3	2, 1, 0	D.2	a, b	XIV
				4	1, 0	D.3		XIV
5	2		E	4, 5	1, 0	E		XV, XVI

in turn depend on the nature of the ring atoms and their substituents.

In the cases of cyclobutane and cyclopentane, if V_3^i for each bond is assumed unchanged⁶⁷ from propane⁶⁸ then B_t^i and A_t^i are negative and positive, respectively. If the B_t^i terms dominate A_t^i , V_t^i and hence V_t will become more negative as x increases. This restates the common conclusion that adjacent methylene groups prefer to be staggered and hence tend to favor the puckered ring.

D. Effects of Substitution of Ring Atoms on $V(x)$

The equilibrium conformation of a ring depends on the form of $V(x)$ which the above arguments show and experiment confirms which is generally

$$V(x) = V_d + V_t = (A_d + A_t)x^4 + (B_d + B_t)x^2 = Ax^4 + Bx^2 \quad (20)$$

Whether $V(x)$ has a single or double minimum and, therefore, whether a four- or pseudo-four-membered ring has a planar or puckered conformation depend on the relative signs and magnitudes of B_d and B_t since A is positive in general. The terms A and B can change considerably when one ring atom is substituted by another. Clearly the equilibrium conformation of a ring is a delicate balance of the competing factors discussed above.

1. Replacement of a Tetrahedral Carbon Atom by a Trigonal Carbon Atom

When a tetrahedral carbon atom in a ring $(CH_2)_n$, where $n = 4$ or 5 is replaced by a trigonal carbon atom (e.g., a $C=O$ group replaces a CH_2 group), the changes that occur are as follows. The ring angle strain increases because the free open-chain values are ~ 120 and $\sim 110^\circ$ for angles at trigonal and tetrahedral carbon atoms, respectively, and hence the s_t and B_d increase. If the same order in V_3 pertains in the rings⁶⁷ as between the open-chain compounds, $(CH_3)_2CH_2$ ⁶⁸ and $(CH_3)_2CO$,⁶⁹ for example, then the appropriate V_3^i decreases on the substitution so that B_t increases. Both changes thus lead to a more positive B term in eq 20, that is, favor the planar ring.

2. Isoelectronic Substitution of CH_2 by NH , O , etc.

When a CH_2 is replaced by NH or O in a ring $(CH_2)_n$, where $n = 4$ or 5, A_d and B_d are assumed to remain unchanged because the appropriate angles in the strain-free compounds $(CH_3)_2CH_2$,⁷⁰ $(CH_3)_2NH$,⁷¹ and $(CH_3)_2O$ ⁷² are essentially the same. If the same order in V_3 pertains in the rings as among these three open-chain compounds,^{68,72,73} then B_t will increase along the series. Isoelectronic substitution will thus favor the planar ring along the series CH_2 , NH , O .

E. Other Factors

The factors other than ring angle strain and the tendency to relieve an eclipsed conformation in a planar ring that can contribute to the determination of the equilibrium conformation are conjugation and steric interactions. Conjugation is generally thought to raise the barrier to internal rotation about the formally single bond that links the pair of double bonds. If a pair of conjugated double bonds occurs in a four- or five-membered ring (one or both of the double bonds can be exocyclic), the restricted rotation will tend to hold that part of the ring planar. Since the net ring angle strain should be unchanged from the hypothetical unconjugated system, conjugation will favor the planar ring.

The effects of steric interactions of substituent atoms or groups on adjacent atoms in a ring can be formally accounted for by considering the appropriate V_3^i terms in eq 18. Steric interactions involving atoms or groups on nonadjacent atoms are much more difficult to discuss.

V. Experimental Conformations of Four- and Five-Membered Cyclic Molecules and Their Classification

A. Introduction

1. Classification

The equilibrium conformations of a large number of (mainly organic) four- and five-membered-ring compounds have now been determined. The experimental results, obtained by the techniques of section III, are classified and summarized with the aid of tables in the present section.

The initial classification, which depends on the number of endocyclic atoms (n) and double bonds (d), is illustrated on the left-hand side of Table I. The values of n and d for each class are given together with the parent molecule and textual location of the class. The division between B and C is merely one of ring size. Molecules in D are pseudo-four-membered rings and accordingly demand separate classification from C, as do those of E which are held rigidly planar by virtue of the two conjugated endocyclic double bonds.

Members of each of the groups B, C and D can then be subclassified with the aid of two simple rules based on the number of endocyclic trigonal carbon atoms t and methylene groups m and suggested by the discussion in section IV.D.

Rule 1: For a given value of n , the planar ring is favored as t increases.

Rule 2: For a given pair of n, t values, the planar ring is progressively favored as m decreases through isoelectronic substitution of CH_2 by NH , O , etc.

Subclassification in terms of t (rule 1) is given on the right-hand

side of Table I together with the textual and tabular locations of each subclass. Each subclass is then further subdivided according to the value of m in locations a, b, c, etc. Sometimes more than one m value per location is convenient. As an example of the use of Table I, cyclopent-3-enone, for which $n = 5$, $d = 1$, $t = 3$, and $m = 2$, is found in section D.2.a. Finally, two miscellaneous groups of four-membered-ring compounds, those containing exocyclically monosubstituted cyclobutanes and molecules based on diborane, are discussed in B.5 and B.6, respectively, and Tables VII and VIII, respectively.

2. Construction of Tables

In order to aid the classification of the equilibrium conformations of ring compounds in this review and provide ready access to them, tables have been constructed. Each table deals with a given subclass of ring compounds (or more than one subclass if the numbers in each are small) and is accompanied by brief textual discussion of the relationships among the conformations found therein.

The arrangement of the columns in the tables is as follows. The structural formula of the compound is given first, followed by the molecular point group appropriate to the equilibrium conformation. Names of the compounds are given in the textual accompaniment. The next set of columns give (when appropriate) some details of the potential-energy function governing the ring-puckering mode(s), including the source of the data from which it was determined, the reference, potential-energy barrier heights, and, for example, angles of puckering at equilibrium. Points of special interest are made by means of footnotes. A similar set of columns refers to the detailed molecular geometry, including the method of determination, the reference, and the type. In most cases a final column gives other references pertaining, usually indirectly, to the conformation in question.

In the tables, barrier heights refer to equilibrium conformations rather than the zero-point level. When the type of molecular geometry derived from an electron-diffraction study is not explicitly stated in the original paper, it is assumed to be of the r_a variety, a procedure followed in a recent compilation.⁷⁴

The abbreviations used in the tables are the following: ED, electron-diffraction technique; FIR, far-infrared spectroscopy; IR, high-resolution infrared spectroscopy; MIRC, mid-infrared combination bands; MW, microwave spectroscopy; R, Raman spectroscopy; RC, Raman combination bands; VA, general vibrational analysis with conclusions about conformation.

B. Four-Membered Rings

1. No Endocyclic Trigonal Carbon Atoms

a. Four Endocyclic Methylene Groups

For the purposes of this classification, CF_2 , CCl_2 , SiH_2 , SiF_2 , etc. are considered as methylene groups. Experimental equilibrium conformations, potential-energy barriers to the ring-puckering motion, and the angle of puckering α (see Figure 1a) for this class of molecule are collected in Table II.

There is general agreement^{38,43,44,75-79} that cyclobutane (1) is puckered at equilibrium. Presumably the torsional forces about ring bonds, which lead to a negative value of B_t in eq 20, dominate the ring angle strain, which leads to a positive value of B_d . If only very small changes of ring angles and bond lengths occur on fluorination of the 1-carbon atom in 1, the less-puckered equilibrium conformation of 1,1-difluorocyclobutane⁸⁰ (2) can be understood by assuming that the $\text{CH}_2\text{-CF}_2$ torsional forces in the planar ring are less than those of $\text{CH}_2\text{-CH}_2$. On this basis, further fluorination should progressively favor planarity (assuming that $\text{CF}_2\text{-CF}_2$ torsional forces are comparable with those of $\text{CH}_2\text{-CH}_2$), but the experimental evidence is contradictory. Thus, 1,1,2,2-tetrafluorocyclobutane (3) appears to have a higher barrier to the planar ring^{81,82} than 2 while octafluoro-

cyclobutane (4) is less puckered according to the electron-diffraction technique,⁸³⁻⁸⁵ planar according to one analysis of its vibrational spectrum⁸⁶ but puckered according to another.^{87,88} The vibrational analysis of 1,1,2,2-tetrachloro-3,3,4,4-tetrafluorocyclobutane (5) is consistent with a planar ring at equilibrium.⁸⁹

The stable form of silacyclobutane (6) is puckered,^{18,90-96} with a barrier to the planar ring and a puckering angle like those of 1. On the other hand, these quantities are reduced in 1,3-disilacyclobutane (7) but the equilibrium conformation is still puckered.⁹⁷⁻⁹⁹ It has been argued⁹⁷ that C-SiC angles are more easily deformed than CCC angles and that the torsional barrier for motion about $\text{SiH}_2\text{-CH}_2$ bonds is smaller than that about $\text{CH}_2\text{-CH}_2$ bonds in the ring. From 1 to 6 the changes in B_d and B_t of eq 20 nearly compensate each other, but for 7, in which only $\text{CH}_2\text{-SiH}_2$ bonds occur, the change in B_t dominates and a reduced barrier results. A similar relationship exists between the 1,1-dichloro-^{92,94,95} and 1,1,3,3-tetrachloro-⁹² analogues (9 and 10, respectively) of 6 and 7. Details of the potential function of 1,1-difluorosilacyclobutane (8) are yet to be determined.⁹⁴

b. Three Endocyclic Methylene Groups

Experimental details for molecules in this class are given in Table III. Although azetidine (11) is puckered at equilibrium,^{20,100-102} it is not known whether the axial or equatorial conformer has the lower energy. The substitution of O for CH_2 in 1 to give oxetane (ref 2-4, 29, 36, 46, 47, 50, 57, 103-111) (12) leads to a large reduction of the barrier to the planar ring. Presumably, the ring angle strain changes little while the reduced torsional forces about the C-O bonds are the dominant factor. In view of the conclusions about 2 when compared with 1, the result that 3,3-difluoro-oxetane (13) is strictly planar at equilibrium¹¹²⁻¹¹⁴ is to be expected, while a potential-energy function for 3,3-dimethyloxetane (14) like that of 12 is also reasonable.¹¹⁵

In thietane^{16,30,42,45,49,64,116-122} (15), the ring angle strain resulting from puckering is reduced relative to 12 because the open-chain angle CSC is less than the corresponding COC angle. Hence torsional forces are more significant in 15 and the barrier to planarity is greater than in 12. A further increase in the barrier occurs in selenetane (16).^{37,123,124}

c. Two Endocyclic Methylene Groups

The only two members of this class studied are included in Table III. In 1,3-dithietane¹²⁵ (17) and its tetrafluoro analogue¹²⁶⁻¹³⁰ 18 only C-S bonds occur, and, therefore, the torsional forces about ring bonds are sufficiently attenuated that ring angle strain prevails; thus for both a planar equilibrium structure is found. It should be noted that the S-oxide of 17¹²⁵ has the puckered equatorial form similar to that of the S-oxide of 15.^{131,132}

No examples of four-membered rings with heteroatoms in the 1,2-positions have been studied. The compound 1,2-dioxetane is an interesting example because it is the precursor of the chemiluminescent material in fireflies. The planar ring would have a cis configuration with respect to the O-O bond, which is energetically unfavorable (see discussion of 1,2,4-trioxacyclopentane (57) below), and, therefore, a puckered equilibrium ring conformation is predicted.

2. One Endocyclic Trigonal Carbon Atom

a. Three Endocyclic Methylene Groups









The results for this class of compounds, in which the increased ring angle strain and decreased torsional barrier about C(tetrahedral)-C(trigonal) bonds resulting from substitution of CH_2 by C=O or C=CH_2 cooperate to favor the planar ring, are shown in Table IV. Thus cyclobutanone (19) is effectively planar^{30,105,118,133-135} while perfluorocyclobutane (20) and the 2-halogenocyclobutanes 21 (X = Cl and Br) are probably so.¹³⁶⁻¹³⁸

TABLE II. Four-Membered Rings with *No* Endocyclic Trigonal Carbon Atoms and *Four* Endocyclic Methylene Groups

molecule	equilibrium conformation	ring-puckering potential function ^a					molecular geometry					
		source of data ^b	ref	barrier to planar ring, cm ⁻¹	dihedral angle ^c (α), deg	notes	method ^b	ref	type ^d	dihedral angle (α), deg	notes	other ref
1	puckered, <i>D</i> _{2d}	MIRC, R MIRC, R MIRC, R	38 43 44	448 ± 18 503 518 ± 5	34.0 ± 0.5 35 ± 5 34.9	<i>e</i> <i>e</i> <i>e</i>	ED	76	<i>r</i> _g	35 ± 5 (<i>r</i> _α)		77 (VA), 78 (MIRC) 79 (MIRC)
2	puckered, <i>C</i> _s	MW	80	241 ± 5	27	<i>h, i</i>						
3	puckered, <i>C</i> ₁	FIR, VA MW	81 82	140 ± 50 >241								
4	planar, <i>D</i> _{4h} puckered, <i>D</i> _{2d}	VA VA	86 87, 88	0 >0	0 >0		ED ED ED	83 84 85	<i>r</i> _g <i>r</i> _a <i>r</i> _a	17.4 ± 0.3 24 ± 3 20 ± 4	<i>g</i>	
5	planar, <i>C</i> _{2v}	VA	89	0	0							
6	puckered, <i>C</i> _s	FIR MIRC MW, FIR	18 90 91	440 ± 3 440 442	37 ± 2	<i>e, g</i> <i>e</i> <i>j</i>	MW ED	91 92, 93	<i>r</i> _o <i>r</i> _a	28 34 ± 2		94 (VA), 95 (VA) 96 (R)
7	puckered, <i>D</i> _{2d}	FIR, R	97	87 ± 1	24 ± 2	<i>g, h, k</i>						98 (MIRC), 99 (VA)
8	puckered, <i>C</i> _s	VA	94			<i>g</i>						95 (VA)
9	puckered, <i>C</i> _s	VA	94			<i>g</i>	ED	92	<i>r</i> _a	30 ± 5		95 (VA)
10	puckered, <i>D</i> _{2d}						ED	92	<i>r</i> _a	14 ± 3		

^a Potential-energy function of reduced type $V(z) = az^4 + bz^2$ unless otherwise noted. ^b See section V.A for list of abbreviations. ^c See Figure 1 for definition. Equilibrium value when determined from potential-energy function unless otherwise noted. ^d See text for discussion of types of geometry. ^e Model of motion assumed in obtaining α from z. ^f Other than most abundant isotopic species. ^g Mixing of ring-puckering mode and CH₂ rocking-mode postulated. ^h Ring-puckering dynamics considered. ⁱ Variation of rotational constants with ring-puckering quantum number used in derivation of potential-energy function. ^j Gaussian term $c \exp(-dz^2)$ included in potential-energy function. ^k Value of α is mean value in zero-point vibrational state.

TABLE III. Four-Membered Rings with No Endocyclic Trigonal Carbon Atoms and Three or Two Endocyclic Methylene Groups

molecule	equilibrium conformation	ring-puckering potential function ^a					molecular geometry						
		source of data ^b	ref	barrier to planar ring, cm ⁻¹	dihedral angle ^c (α), deg	notes	method ^b	ref	type ^d	dihedral angle ^c (α), deg	notes	other ref	
 11	puckered, C _s	FIR	20	441	-	<i>e</i>	ED	100	<i>r</i> _a	33.1 ± 2.4		102 (R)	
			101				ED	101	<i>r</i> _a	35.1	<i>f</i>		
 12	puckered, C _s	FIR	103	-			MW	3	<i>r</i> _s	(0)	<i>g</i>	36 (MIRC), 105 (MIRC) 106 (MIRC), 107 (R) 47 (R, MIRC), 108 (MIRC) 46 (RC), 109 (MIRC)	
			1	-		<i>h, i, j</i>							
			2	35 ± 5		<i>h, j, k</i>							
			3			<i>h, j, k, l</i>							
			4	15.3 ± 0.5		<i>h, j</i>							
			104	15.1 ± 0.5		<i>h</i>							
				11.3 to 9.6		<i>h, m</i>							
	FIR	29	15.52 ± 0.02		<i>n</i>	MW	110	<i>r</i>		<i>o</i>			
	MW	50, 51	(15.1)		<i>p</i>	MW	111	<i>r</i> _s , <i>r</i> _o	(0)	<i>g</i>			
 13	planar, C _{2v}	MW	112	0	0	<i>j</i>							
			FIR, MW	113	0	0							<i>h, j, l</i>
			MIRC, VA	114	0	0							
 14	puckered, C _s	FIR, MW	115	46.4 ± 1.6	-	<i>j</i>							
 15	puckered, C _s	MW	16, 116	274 ± 2	28	<i>j, l</i>	ED	119	<i>r</i> _α ^o	26 ± 4		117 (MW), 118 (FIR)	
			30	(274 ± 2)	-	<i>q</i>							
			45	(274 ± 2)	-	<i>q</i>							
			49	277 ± 5	-	<i>j</i>							
			122	271.8 ± 2.1	-								
				265.9 to 263.9	-	<i>m</i>							
	R	42	as in ref 122	-	<i>m</i>	ED + MW	64	<i>r</i> _{av}	26 ± 2		120 (MW) 121 (MIRC)		
 16	puckered, C _s	FIR, MIRC	123	378.1 ± 4	32.5 ± 2	<i>h</i>						37 (FIR, MIRC)	
			124	383.1 ± 4	29.5 ± 1	<i>h, j, l</i>							
 17	planar, D _{2h}	MW	125	0	0	<i>r</i>							
 18	planar, D _{2h}	FIR, R, VA	126	0	0		ED	127	<i>r</i> _a	0 (ass) ^s		129 (ED)	
							ED	128	<i>r</i> _a	0 (ass) ^s		130 (VA)	

^a Potential-energy (PE) function of reduced type $V(z) = az^4 + bz^2$ unless otherwise noted. ^b See section V.A for list of abbreviations. ^c See Figure 1 for definition. Equilibrium value when determined from PE function unless otherwise noted. ^d See text for discussion of geometry type. ^e PE function $V(z) = az^4 + bz^2 + cz^3$ used. Axial and equatorial conformers differ in energy by 91 cm⁻¹ but not identified. ^f Value of α here is that appropriate to ref 101 but corrected as in ref 100. ^g Geometry refers to hypothetical planar ring. ^h Model of motion assumed in deriving α from *z*. ⁱ PE function $V(z) = bz^2 + c \exp(-dz^2)$ used. ^j Variation of rotational constants with ring-puckering quantum number used in derivation of PE function. ^k Gaussian term $c \exp(-dz^2)$ included in $V(z)$. ^l Ring-puckering dynamics considered. ^m Range of values of several less abundant isotopic species. ⁿ Term in z^6 included in $V(z)$. ^o Tilts and twists of CH₂ groups at equilibrium established. ^p Dependence of centrifugal distortion constants on ring-puckering quantum number consistent with PE function of ref 104. ^q Observed spacings from FIR and R agree with predictions of ref 16. ^r Absence of microwave rotational spectrum implies planar ring. ^s Assumed.

TABLE IV. Four-Membered Rings with One Endocyclic Trigonal Carbon Atom and Three or Two Endocyclic Methylene Groups

molecule	equilibrium conformation	ring-puckering potential function ^a					molecular geometry					
		source of data ^b	ref	barrier to planar ring, cm ⁻¹	dihedral angle ^c (α), deg	notes	method ^b	ref	type ^d	dihedral angle ^c (α), deg	notes	other ref
three endocyclic CH ₂ groups												
	puckered, C _s	FIR	118	~0	-	<i>e</i>	MW	133	<i>r_s</i>	effectively planar		134 (MW), 105 (MIRC)
19		FIR	30	~5	-	<i>f</i>	MW	135	<i>r_s</i>	effectively planar	<i>g</i>	
		MW, FIR	133	7.6 ± 2		<i>h, i</i>						
	planar, C _{2v}	VA	136	0	0							118 (FIR)
20												
	X = Cl; planar, X = Br; planar, C _s											137 (VA, FIR) 138 (VA, FIR)
21												
	puckered, C _s	MW	139	160 ± 40	-	<i>h, j</i>	ED	140	<i>r_a</i>	assumed planar		
22		MIRC	39	168 ± 10	-	<i>f</i>						
		R	45	141 ± 5	-	<i>f</i>						
	puckered, C _s , CN equatorial						MW	141	<i>r_o</i>	(17)	<i>k</i>	
23												
two endocyclic CH ₂ groups												
	planar, C _{2v}	FIR	28	0	0	<i>f</i>	MW	15	<i>r_s</i> and <i>r_o</i>	0		
24		MW	15	0	0	<i>h, l</i>						
	planar, C _{2v}	VA, FIR	142	0	0		MW	143	<i>r_o</i>	0		<i>k</i>
25		MW, FIR	143	0	0	<i>h, l, m</i>						
	puckered, C ₁	MW	144	very small or 0	-	<i>h, n</i>						146 (VA, MIRC), 147 (MW)
26		MW	145	19	-	<i>h, n, o</i>						148 (MW)
	probably planar, C _s	MW	149	0	-	<i>h</i>						
27		FIR	150	0	-							
	planar, C _{2v}	FIR	151	0	0	<i>f</i>	MW	152	<i>r_o</i>	0		<i>k</i>
28		MW, FIR	152	0	0	<i>f, h, l</i>						

^a Potential-energy (PE) function of reduced type $V(z) = az^4 + bz^2$ unless otherwise noted. ^b See section V.A for list of abbreviations. ^c See Figure 1 for definition. Equilibrium value when determined from PE function unless otherwise noted. ^d See text for discussion of geometry type. ^e All $\nu + 1 \leftarrow \nu$ transition of ring-puckering mode except $\nu = 0$ and $\nu = 1$ fitted by using $V(z) = az^4$ only. ^f Model of motion assumed in deriving α from z . ^g Tilt angle of $4.6 \pm 0.8^\circ$ between HC₂H plane and bisector of angle C₁C₂C₃. ^h Variation of rotational constants with ring-puckering quantum number used in derivation of PE function. ⁱ Gaussian term $c \exp(-dz^2)$ included in $V(z)$. ^j Dependence of electric dipole moment on ring-puckering quantum number discussed. ^k Assumed geometry consistent with moments of inertia. ^l Ring-puckering dynamics considered. ^m Assignment of FIR spectrum modified. ⁿ Vibrational separations from MW relative intensity measurements. ^o $V(z) = bz^2 + c \exp(-dz^2)$ used for PE function.

Methylenecyclobutane (**22**) is puckered^{39,45,139,140} but with a barrier to the planar ring less than that in cyclobutane (**1**) while 3-methylenecyclobutane (**23**) has a smaller puckering angle¹⁴¹ than **1**.

b. Two Endocyclic Methylene Groups

Substitution of CH₂ by O in the 3-positions of **19** and **22** reduces the forces tending to pucker the ring (see section IV.D), and consequently both 3-oxetanone^{15,28} (**24**) and 3-methylenoxetane^{142,143} (**25**) have strictly planar rings at equilibrium. When substitution is at the 2-position in **19**, however, there remains a pair of CH₂ groups eclipsed in the planar ring. The resulting torsional forces in 2-oxetanone (**26**) are sufficient to preserve a small barrier to the puckering motion,¹⁴⁴⁻¹⁴⁸ but in 4-methyl-2-oxetanone (**27**) even this vestige is no longer apparent.^{149,150}

If S rather than O is substituted in the 3-position of **19**, the result is 3-thietanone^{151,152} (**28**) in which, like **24** and **25**, the planar ring has no adjacent eclipsed CH₂ groups. Consequently **28** too has a planar equilibrium ring conformation.

c. One Endocyclic Methylene Group

No example of this class has been investigated. The chemiluminescent material in fireflies, 1,2-dioxetan-3-one, is one member of this class of some importance.

3. Two Endocyclic Trigonal Carbon Atoms

In the discussion of section VI.B, it was indicated that strained angles in a planar four-membered ring will usually contribute positive quadratic terms (x^2) to the ring-puckering potential function. As the number of trigonal carbon atoms increases in a four-membered ring, it is therefore expected that the equilibrium conformation will first tend to become planar and then the ring-puckering potential function will become increasingly like that of a harmonic oscillator. When one such carbon atom is present, the potential function can be either essentially quartic, as in **19**, or have a large positive quadratic term in x , as in **24**, depending on the relative signs and extent of cancellation of the B_d and B_t terms in eq 20. When two or more trigonal carbon atoms are present, B_t is less negative and B_d is larger, more positive, and dominant. Essentially harmonic oscillator behavior of the ring-puckering mode is then observed, mainly through the linear variation of B_t with ν since the far-infrared (or infrared) spectrum gives little information about the puckering mode, and this is the case for molecules in this class shown in Table V.

a. Two Endocyclic Methylene Groups







All molecules in this class (see Table V) have strictly planar equilibrium ring conformations with essentially harmonic ring-puckering modes. In cyclobutene¹⁵³⁻⁵ (**29**), 3,4-dichlorocyclobutene^{158,157} (**30**), and perfluorocyclobutene⁸³ (**31**) planarity is additionally favored by the restriction of torsional motion about the formal double bond while in cyclobutene-1,2-dione^{158,159} (**32**) and 1,2-dimethylenecyclobutane¹⁶⁰ (**33**) some endocyclic double-bond character arising from conjugation is likely. In each case the equilibrium conformation has a pair of adjacent, eclipsed methylene groups (or their equivalent).

Although cyclobutene-1,3-dione (**34**) has been studied only in the solid and liquid phases, it is included in Table V as the only example of the class in which the trigonal carbon atoms are in the 1,3-positions. Here, both ring angle strain and torsional forces favor the planar ring.¹⁶¹

b. One Endocyclic Methylene Group

The only example of this type studied is 4-methylene-2-oxetanone (diketene, **35**, see Table V). As expected, the equilibrium conformation of the ring is strictly planar.^{162,163}

TABLE V. Four-Membered Rings with Two Endocyclic Trigonal Carbon Atoms and Two or One Endocyclic Methylene Groups

molecule	equilibrium conformation	molecular geometry				
		meth-od ^a	ref	type ^b	notes	other ref
two endocyclic methylene groups						
	planar, C _{2v}	MW	153	r _s		154 (MW), 155 (VA)
	planar, C _s	ED	156	r _a		157 (VA)
	planar, C _{2v}	ED	83	r _a		
	planar, C _{2v}	MW	158, 159	(r ₀)	c, d	
	planar, C _{2v}	MW	160	(r ₀)	c, d	
	planar, D _{2h}	-	-	-	e	161 (VA)
one endocyclic methylene group						
	planar, C _s	MW	162	-	d	163 (VA)

^a See section V.A for list of abbreviations. ^b See text for discussion of geometry type. ^c Assumed geometry consistent with ground-state moments of inertia. ^d Variation of rotational constants with ring-puckering quantum number used to infer equilibrium ring conformation. ^e Solution and solid phases only.



4. Four Endocyclic Trigonal Carbon Atoms

Like the molecules of section V.A.3, no potential-energy function for the ring-puckering mode of molecules of this category has been explicitly derived, suggesting that the mode is again essentially harmonic and that the fundamental falls at high wavenumber. Thus for 3,4-dimethylenecyclobutene¹⁶⁴⁻¹⁶⁶ (**36**), its perchloro analogue¹⁶⁷ **37**, 3-methylenecyclobutene-4-one^{168,169} (**38**), and tetramethylenecyclobutane¹⁷⁰ (**39**), the equilibrium conformation, which is rigidly planar in each case, has been inferred mainly by geometrical techniques (see Table VI).

5. Exocyclically Monosubstituted Cyclobutanes

When a single group is substituted for a hydrogen atom in cyclobutane, the resulting monosubstituted derivatives have ring-puckering modes governed by a potential-energy function which is not necessarily symmetric in the puckering coordinate x or z but which generally contains both even and odd powers (see eq 5, section II.B). As a result, the far-infrared and Raman spectra associated with the ring-puckering mode are more complicated and difficult to analyze. Most authors have used a reduced function of the general type shown in eq 5, from which the linear term is eliminated by assuming that the maximum in $V(z)$ occurs at $z = 0$, corresponding to the planar ring. Since this is not necessarily so, there is no possibility of finding the true values of z , x , and thus α at the minima. Nevertheless, the general conclusion, confirmed by microwave spectroscopy and electron diffraction in most cases, is that the lowest energy form is puckered with the substituent equatorial. The experimental results for the monosubstituted cyclobutanes **40** where

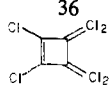
TABLE VI. Four-Membered Rings with Four Endocyclic Trigonal Carbon Atoms

molecule	equilibrium conformation	molecular geometry			remarks	other ref
		method ^a	ref	type ^b		
	planar, C_{2v}	ED MW	164 165	r_a -	c	166 (MW)
	planar, C_{2v}	ED	167	r_a	d	
	planar, C_s	MW	168	(r_o)	c, e	169 (MW)
	planar, D_{4h}	VA	170	-		

^a See section V.A for list of abbreviations. ^b See text for discussion of geometry type. ^c Planarity established on basis of small inertia defect $\Delta_0 = I_c^0 - I_a^0 - I_b^0$. ^d Geometry of carbon framework essentially unchanged from 36. ^e Assumed geometry consistent with ground-state moments of inertia.

X = F, Cl, Br, OH, OCH₃, NH₂, CN, and COCl are summarized^{19,171-189} in Table VII. No direct evidence has been obtained for another stable conformer in any case, although a planar or an axial puckered form has been inferred from the potential-energy function derived from observations on the equatorial conformer in some cases while for others an inflection rather than another minimum is inferred in the curve.

Table VII shows that when two stable conformers do occur there is an energy barrier of ~ 800 – 1000 cm⁻¹ for the equatorial form to surmount in achieving the other form. This is rather higher than in cyclobutane.

6. Molecules Based on Diborane

Diborane¹⁹⁰⁻¹⁹⁴ (41) and molecules based on it¹⁹⁵⁻²⁰¹ form an interesting group, experimental details of which are recorded in Table VIII. Although it was in connection with 41 that Bell⁵ first suggested a ring-puckering potential-energy function quartic in the coordinate x , it has been shown¹⁹⁰ that the function is predominantly quadratic in x . This can be understood in terms of highly strained angles in the planar ring (large positive B_d in eq 20) and the absence of torsional forces about ring bonds ($A_i = B_i = 0$ in eq 20). It has been suggested¹⁹⁰ that the B_d and B_i terms largely cancel in many four-membered rings but that in 41 this is not the case. Similar conclusions apply to μ -aminodiborane¹⁹⁸ (43) and μ -mercaptodiborane¹⁹⁹ (45). The equilibrium conformation of the ring in 41, 43, 45, bromodiborane¹⁹⁵ (42), N,N -dimethyl- μ -aminodiborane¹⁹⁸ (44), dimethyldiborane²⁰⁰ (46), and the tetramethyl analogue²⁰¹ 47 is planar in each case.

C. Saturated Five-Membered Rings

As discussed in section II.B, saturated five-membered rings have two puckering modes which can be discussed conveniently in terms of one of several types of two-dimensional potential-energy surfaces. The cases encountered here range from essentially free pseudorotation to that in which the potential barrier along the pseudorotational path is higher than the barrier to the planar ring. The existence and magnitude of a pseudorotational barrier depend on the extent of the similarity of potential energy in the half-chair (twisted) C_2 and bent C_s ring conformations shown in Figure 3. The potential energy of a given conformation in turn depends on the contributions arising from ring angle deformation and torsional motion about ring bonds. A discussion of the origin of the barrier to pseudorotation in five-membered rings in terms of these contributions has been given by Pitzer and Donath.²⁰²

1. No Endocyclic Trigonal Carbon Atoms

a. Five Endocyclic Methylene Groups

The experimental equilibrium conformation of the ring, details of the two-dimensional potential-energy surface governing the ring-puckering modes, and the type of geometry available for members of this class are collected in Table IX.

Cyclopentane^{24,25,32,33,203-205} (48) has a potential-energy surface of the type shown in Figure 4. The C_2 and C_s forms have essentially identical energy and as a result the barrier to pseudorotational motion is effectively zero. The high barrier to the planar ring can be understood in terms of small ring angle strain in the D_{5h} conformation coupled with five eclipsed adjacent CH₂ groups.

Pitzer and Donath²⁰² have shown, by considering torsional barriers from suitable model compounds, that a barrier will generally be presented to the pseudorotational motion when a substitution is made at or on a ring atom in cyclopentane. The C_2 or C_s form is then the more stable depending on whether the torsional barriers for bonds involving the substituted atom are lower or higher, respectively, than the corresponding value for the C–C bond.

The pseudorotational barriers for silacyclopentane^{34,35,207-210} (50) and germacyclopentane²¹¹⁻²¹³ (51) are almost as high as the barrier to the planar ring, corresponding to a potential-energy surface of the type shown in Figure 7. A high barrier to pseudorotation coupled with the C_2 form as the lowest energy conformer can be interpreted²⁰² in terms of decreased contribution to the potential energy from torsion about the CH₂–MH₂ bonds (M = Si, Ge) compared with that from CH₂–CH₂ bonds. This would also favor the planar ring relative to 48. 1,1-Difluorocyclopentane (49) is a similar case but with a lower barrier to pseudorotation.²⁰⁸ Cyclopentasilane (52) behaves in a manner^{214,215} similar to cyclopentane. A vibrational analysis of the perfluoro analogue of 52 has also been reported.²¹⁶

The monohalogenated cyclopentanes²¹⁷⁻²²¹ have more complicated potential-energy surfaces because of the possibilities of additional minima associated with axial and equatorial conformers. Some progress has nevertheless been possible in these cases also by using the far-infrared and microwave techniques.

b. Four Endocyclic Methylene Groups

The experimental information available for saturated five-membered-ring compounds in this category is summarized in Table X.



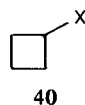



TABLE VII. Exocyclically Monosubstituted Cyclobutanes



molecule	most stable conformation	ring-puckering potential function ^a					molecular geometry					
		source of data	ref	barrier to interconversion, ^c cm ⁻¹	energy difference of other conformer, cm ⁻¹	notes	method ^b	ref	type ^d	dihedral angle ^e (α), deg	notes	other ref
X = F	puckered, equatorial, C _s	FIR, R	171	803	722	<i>f, g</i>						
		R	172	929	872	<i>f, h</i>						
X = Cl	puckered, equatorial, C _s	IR	19	-	~350	<i>i</i>	MW	173	r ₀	20 ± 2		174 (FIR, VA), 172 (R)
		FIR	177	824	~770	<i>f</i>						175 (FIR, VA), 176 (FIR)
X = Br	puckered, equatorial, C _s	FIR	178	-	~350	<i>j</i>	MW	179	r ₀	29.4 ± 0.2		174 (FIR, VA), 180 (VA)
		IR, MW	19	-	~350	<i>i, k</i>						
		FIR	177	-	-	<i>f, l</i>						
X = OH	puckered, equatorial (trans), C _s	FIR, R	182	~1000 ~700-900	~1000 ~50-150	<i>f, m</i> <i>f, g</i>	MW	183	r ₀	20	<i>n</i>	184 (FIR, VA)
X = OMe	puckered, equatorial (gauche), C ₁											185 (R, VA)
X = NH ₂	puckered, equatorial (trans + gauche), C _s , C ₁	FIR, R	186	975	913	<i>f</i>						
X = CN	puckered, equatorial, C _s	FIR	177	-	-	<i>f, l</i>	MW	187	r ₀	21.4	<i>n</i>	
							MW	188	r ₀	20	<i>n</i>	
X = COCl	puckered, mixed equatorial and axial (all gauche)						ED	189	r _g	21 ± 5		





^a Potential-energy (PE) function of reduced asymmetric type $V(z) = az^4 + bz^2 + cz^3$ unless otherwise noted. ^b See section V.A for list of abbreviations. ^c PE barrier presented to most stable conformer. ^d See text for discussion of geometry type. ^e See Figure 1 for definition. ^f Unreduced PE function derived by using reduced mass from model. ^g More than one PE function consistent with the data. ^h Assignment of ref 171 modified in this work. ⁱ From temperature dependence of IR spectrum. ^j $V(z)$ also contains term in z . No distinct minimum at axial form, merely an inflection. ^k Temperature dependence of IR spectrum and behavior of vibrational satellites in MW spectrum used in deriving $V(z)$ with inflection ~350 cm⁻¹ above zero-point level. ^l FIR spectrum consistent only with single minimum in $V(z)$. ^m Assignment of ref 177 changed. ⁿ Assumed geometry consistent with ground-state rotational constants.

TABLE VIII. Molecules Based on Diborane

molecule	equilibrium conformation	ring-puckering potential function ^a					molecular geometry			
		source of data ^b	ref	barrier to planar ring, cm ⁻¹	notes	method ^b	ref	type ^c	notes	
 41	planar ring, <i>D</i> _{2h}	FIR R	190 192	0 0	<i>d, e</i> <i>d</i>	IR ED ED + IR	191 193 194	<i>r</i> ₀ <i>r</i> _g <i>r</i> _z		
 42	planar ring, <i>C</i> _s	-	-	-		MW	195	<i>r</i> _s		
 43	planar ring, <i>C</i> _{2v}	FIR	196	0	<i>d, e</i>	MW	197	<i>r</i> _s	<i>f</i>	
 44	planar ring, <i>C</i> _{2v}	-	-	-		MW	198	<i>r</i> ₀	<i>f</i>	
 45	planar ring, <i>C</i> _{2v}	FIR	199	0	<i>d, e</i>					
 46	planar ring, cis, <i>C</i> _{2v} ; trans, <i>C</i> _{2h}	VA	200	-		ED	200	-	<i>g</i>	
 47	planar ring, <i>D</i> _{2h}	-	-	-		ED	201	<i>r</i> _g		

^a PE function of the reduced type $V(z) = az^4 + bz^2$ unless otherwise noted. ^b See section V.A for list of abbreviations. ^c See text for discussion of geometry type. ^d Unreduced PE function $V(x) = Ax^4 + Bx^2$ derived. ^e Dynamics of ring-puckering motion discussed. ^f BH₂ groups tilted by ~16° from plane perpendicular to the *C*₂ axis towards N. ^g ED determination of structures referred to in ref 200.

TABLE IX. Five-Membered Rings with No Endocyclic Trigonal Carbon Atoms and Five Endocyclic Methylene Groups

molecule	equilibrium conformation ^b	ring-puckering potential-energy surface ^a					molecular geometry				other ref
		source of data ^c	ref	barrier ^d to pseudorotation, cm ⁻¹	barrier ^e to planar ring, cm ⁻¹	notes	method ^c	ref	type ^f	notes	
 48	puckered, <i>C</i> _s and <i>C</i> ₂	MIRC	32	0 (ass)	-	<i>g</i>	ED	203	<i>r</i> _g		204 (IR), 33 (IR)
		MIRC	24	0 (ass)	1930 ± 50	<i>g, h</i>					
		MIRC, R	25	0 (ass)	1824 ± 50	<i>g, h</i>					
		MIRC	205	<20	-	<i>i</i>					
 49	puckered, <i>C</i> ₂	MW	206	280 ± 20	-						
 50	puckered, <i>C</i> ₂	FIR, MIRC	34	1362 ± 25	-		MW	207	<i>r</i> ₀	<i>j</i>	208 (VA)
		FIR, MIRC	209	1360	-		ED	210	<i>r</i> _g		
		FIR, R	35	1414	1559	<i>h</i>	MW + ED	210	<i>r</i> _z		
 51	puckered, <i>C</i> ₂	FIR, MIRC	211	2060	-		MW	212	<i>r</i> ₀	<i>j</i>	
		FIR, R	213	1454	1474	<i>h</i>					
 52	puckered, <i>C</i> _s and <i>C</i> ₂	-	-	-	-		ED	214	<i>r</i> _a	<i>k</i>	215 (VA)







^a See section II.B for discussion. ^b See Figure 3 for half-chair *C*₂ and bent *C*_s forms of a five-membered ring. ^c See section V.A for list of abbreviations. ^d PE barrier between equivalent lowest energy forms. Determined by using a one-dimensional PE function $V(\phi)$ unless otherwise stated. ^e PE barrier between equilibrium conformation and planar ring. ^f See text for discussion of geometry type. ^g Free pseudorotation assumed. ^h Radial and pseudorotational motions not assumed separable. Two-dimensional PE surface fitted to radial and pseudorotational energy levels. ⁱ Failure to observe splitting in pseudorotational transitions places upper limit on V_{10} , tenfold barrier. ^j Some structural parameters assumed. ^k *C*_s or *C*₂ form fit ED data equally well. Evidence for rapid pseudorotation from ref 215.

The barrier to pseudorotation in oxacyclopentane (tetrahydrofuran, **53**) is very low and the two-dimensional potential-energy surface is of the type shown in Figure 5.^{8,24,31,222-224} The stable conformer is neither the *C*_s nor the *C*₂ form but is midway between the two. The barrier to the planar ring is decreased

from cyclopentane, presumably because of the reduced torsional barrier about the C-O bonds in **53** relative to that about C-C bonds.

Thiacyclopentane²²⁵⁻²²⁶ (**54**) and selenacyclopentane²²⁹⁻²³³ (**55**) both have the *C*₂ form as the most stable conformation,

TABLE X. Five-Membered Rings with *No* Endocyclic Trigonal Carbon Atoms and *Four or Less* Endocyclic Methylene Groups

molecule	stable equilibrium conformation ^b	source of data ^c	ref	ring-puckering potential-energy surface ^a							
				barrier to pseudorotation, ^d cm ⁻¹	barrier to planar ring, ^e cm ⁻¹	notes	molecular geometry				
							meth- od ^c	ref	type ^f	notes	other ref
 53	puckered, midway between <i>C_s</i> and <i>C₂</i>	FIR	222	~0 (ass)	-		ED	223, 224	<i>r_g</i>		
		FIR	31	~50	-						
		MW	8	57	1220	<i>g, h</i>					
		FIR	24	-	1350 ± 75	<i>i</i>					
 54	half-chair <i>C₂</i>	FIR	225	773	-		MW	226	(<i>r_o</i>)	<i>j</i>	228 (MW)
		ED						227	<i>r_a</i>		
 55	half-chair <i>C₂</i>	FIR, R	229	1882	-		MW	230	<i>r_s</i>		231 (MW)
		FIR, R	232	-	1693	<i>i</i>	ED	233	<i>r_a</i>		
 56	puckered, midway between <i>C₂</i> and <i>C_s</i>	FIR	234	0 (ass)	-						
		MW	235	~45	-	<i>g</i>					
		FIR	24	-	1120 ± 75	<i>i</i>					
 57	half-chair <i>C₂</i>	MW	237	>600	-		MW	237	<i>r_o</i>		238, 239 (MW)
								240, 241	<i>r_s</i>		
								ED	242	<i>r_a</i>	
 58	half-chair <i>C₂</i>	MW	248	-	-	<i>k</i>	MW	248	<i>r_s</i>		
 59	planar, <i>C_{2v}</i>						MW	249	<i>r_s</i>		250 (VA)

^a See section II.B for discussion. ^b See Figure 3 for half-chair *C₂* and bent *C_s* forms of a five-membered ring. ^c See section V.A for list of abbreviations. ^d PE barrier between lowest energy conformers for inversion via pseudorotation. Determined by using one-dimensional PE function $V(\phi)$ unless otherwise noted. ^e PE barrier between equilibrium conformation and planar ring. ^f See text for discussion of geometry type. ^g Lowest energy conformer is between the *C₂* and *C_s* forms which occur at maxima along the pseudorotational path. ^h Dynamics of pseudorotation discussed. ⁱ Radial and pseudorotational modes assumed *not* to be independent. Two-dimensional PE surface fitted to radial and pseudorotational energy levels. ^j Ground-state rotational constants consistent with half-chair *C₂* form. ^k Effectively planar. Dependence of rotational constants on the ring-puckering quantum number indicates a barrier lower than zero-point energy.

but in both the energy required to invert the conformation via pseudorotation is *higher* than that required for direct inversion through the planar ring. According to Pitzer and Donath,²⁰² this result implies a barrier to torsional motion about C-X ring bonds (X = S, Se) considerably lower than that about C-C ring bonds. The order of the barrier to planarity X = CH₂ > Se > O in (CH₂)_nX is the same for n = 4 as in the corresponding cases when n = 3, but the position of X = S appears to differ between n = 3 and n = 4.

c. Three Endocyclic Methylene Groups

A further substitution of O for CH₂ in the 3-position of **53** gives 1,3-dioxacyclopentane (**56**; see Table X) which has a two-dimensional potential-energy surface very similar to that of **53**.^{24,234,235} The additional C-O bonds in the ring of **56** lead to a further reduction of the barrier to the planar ring. Pseudorotation in the 2-methyl derivatives of **53** and **56** has been discussed.²³⁶

d. Two and Less Endocyclic Methylene Groups

Molecules in this group are also included in Table X. A further substitution of O for CH₂ in the 4-position of **56** to produce 1,2,4-trioxacyclopentane²³⁷⁻²⁴² (**57**) has the initially surprising result that the barrier to pseudorotation is increased from 45 to >600 cm⁻¹, as indicated by the behavior of the rotational constants as a function of the ring-puckering quantum numbers in **57**. Such a result can be rationalized, however, when it is noted that in hydrogen peroxide²⁴³ the barrier to formation of the cis form from the stable book form is 2460 cm⁻¹. The equilibrium (*C₂*) conformation of **57** is book-like with respect to bonds attached to the adjacent oxygen atoms, and presumably the potential energy rises steeply in approaching the *C_s* con-

formation, in which the arrangement with respect to the O-O group is like that in cis hydrogen peroxide. The stable *C₂* form with a high barrier to pseudorotation is then expected. The 3-fluoro,²⁴⁴ 3-methyl, and 3,5-dimethyl analogues^{245,248} of **57** exist in the half-chair form, with F axial in the first, CH₃ equatorial in the second, and both CH₃ groups equatorial in the trans form of the third. The 3,3-difluoro derivative²⁴⁷ of **57** has a stable conformer lower in energy by at least 300 cm⁻¹ than the other but these are yet to be identified.





Evidence from the rotational spectrum favors a very low barrier (below the zero-point level) to the planar ring in 1,3,2-dioxaborolane²⁴⁶ (**58**) while in 1,2,4-trioxadiborolane^{249,250} (**59**) the atoms are strictly coplanar at equilibrium. Clearly some property of the BH groups which replace the CH₂ groups in forming **59** from **57** allows the O-O grouping to adopt the cisoid conformation. Electron-diffraction studies of the 3,5-dichloro²⁵¹ and 3,5-dimethyl derivatives²⁵² of the 1,2,4-trithia analogue of **59** are consistent with a planar molecule in each case.

2. One Endocyclic Trigonal Carbon Atom

a. Four Endocyclic Methylene Groups

Cyclopentanone^{28,253-260} (**60**) and methylenecyclopentane^{261,262} (**61**) are the only members of this class so far investigated (see Table XI for details). It is firmly established that **60** has the half-chair equilibrium conformation and that the appropriate two-dimensional potential-energy surface is that of Figure 7. The bending mode is lower in frequency than the twisting mode and interconversion between equivalent *C₂* forms is most facile through the planar ring which is ~750 cm⁻¹ higher in energy.²⁵⁹ This smaller barrier to planarity than in cyclopentane is consistent with the increased angle strain in the planar ring and reduced

TABLE XI. Saturated Five-Membered Rings with One or Two Endocyclic Trigonal Carbon Atoms

molecule	equilibrium conformation ^b	ring-puckering potential function ^a				molecular geometry			other ref
		source of data ^c	ref	barrier, cm ⁻¹	notes	method	ref	type ^d	
	puckered, C ₂	MW	253	>400	<i>e</i>	MW	253	<i>r</i> ₀	254 (FIR), 255, 256, 257 (VA)
		FIR	28	1303	<i>f</i>	MW	258	<i>r</i> ₀	
		FIR	259	~750	<i>g</i>	ED	260	<i>r</i> _a	
	puckered, C ₂	MW	261	-	<i>h</i>				
		MIRC	262	-		<i>i</i>			
	puckered, C ₁	MW	263, 264	lower than in 60	<i>j</i>				254 (FIR)
		R	265						
	puckered, C ₂ (?)	MW	266	lower than in 61	<i>j</i>				254 (FIR), 267 (VA)
	planar, C _{2v}					ED	268	<i>r</i> _a	

^a For type of function see notes. ^b See Figure 3 for C₂ conformation of five-membered ring. ^c See section V.A for list of abbreviations. ^d See text for discussion of geometry type. ^e From variation of rotational constants with ring-bending mode quantum number. ^f Using a one-dimensional treatment of pseudorotation. ^g FIR data analyzed by using a two-dimensional potential surface. ^h Rotational constants and electric dipole moment consistent with C₂ conformer. ⁱ One-dimensional PE function for ring-bending fitted to data. ^j See text for discussion.

torsional barrier about CH₂-CO bonds which attend substitution of CH₂ by C=O.

Less is known about **61**, but a ring-bending vibrational satellite pattern in the rotational spectrum²⁶¹ similar to that in **60** makes it likely that a rather similar potential-energy surface obtains. The far-infrared spectrum of **61** is readily interpreted in terms of an essentially harmonic, one-dimensional bending mode of a molecule having a half-chair (C₂) equilibrium conformation.²⁶²

b. Three or Less Endocyclic Methylene Groups

Little is known about the two-dimensional potential-energy surface for oxacyclopentan-2-one (γ -butyrolactone, **62**)²⁶³⁻²⁶⁵ and 1,3-dioxacyclopentan-2-one (ethylene carbonate, **63**),^{268,267} as can be seen from Table XI. Indeed, it is not even known whether the puckered equilibrium conformation is of the bent or half-chair form. If, by analogy with **60**, it is the half-chair and the most facile route to inversion is through the planar ring, some evidence from microwave spectroscopy suggests that the order of the barrier is **60** > **62** > **63**. In **63** all ground-state rotational transitions show inversion doubling,²⁶⁶ while in **62** only very high *J* transitions are so affected²⁶⁴ and in **60** no doubling occurs even in states having six quanta of the ring-bending mode excited.²⁵³ Thus, progressive substitution of CH₂ by O in **60** appears to lower the energy barrier to the planar ring.

3. Two Endocyclic Trigonal Carbon Atoms

In succinic anhydride (**64**; see Table XI) the ring angle strain conferred on the planar ring by two trigonal carbon atoms is sufficient to hold the pair of adjacent methylene groups eclipsed in the equilibrium conformation.²⁶⁸ The electron diffraction data for the perfluoro analogue of **64** are also consistent with an equilibrium planar ring.²⁶⁹

D. Five-Membered Rings with One Endocyclic Double Bond (Pseudo-Four-Membered Rings)

The resistance to torsional motion about the endocyclic double bond ensures that the ring-twisting mode in these molecules is usually significantly higher in frequency than the ring-bending

mode and allows the latter to be discussed by using a one-dimensional potential-energy function in a manner similar to that employed for the puckering mode of four-membered rings. The appropriate ring puckering coordinate in this case has been defined in Figure 1b.

1. Two Endocyclic Trigonal Carbon Atoms

a. Three Endocyclic Methylene Groups







Details of the ring-puckering potential function and the type of geometry available for molecules of this group are recorded in Table XII. Cyclopentene (**65**) and its perfluoro analogue **66** are puckered at equilibrium,^{12,36,49,57,105,270-280} a result which can be rationalized by consideration of eq 20. The term *B*₁ can be rewritten⁶⁵ as *D*₁ + *E*₁, where *D*₁ arises from the torsional barriers to rotation about the CH₂-CH₂ bonds and *E*₁ arises analogously from =CH-CH₂ bonds. In cyclopentene-like molecules, *D*₁ is negative and *E*₁ is positive. Since *B*₀ is positive when angles of the planar ring are strained, the sign of the coefficient of *x*²

$$B = B_0 + D_1 + E_1 \quad (21)$$

depends on the relative magnitudes of *B*₀ + *E*₁ and *D*₁. In **65** the term *D*₁ is dominant, *B* is negative, and a puckered ring results. Pyrazoline (**67**), which is isoelectronic with **65**, is also puckered but with a reduced barrier to the planar ring and smaller dihedral angle²⁸¹ (see Figure 1b for definition).

Experiment shows that silacyclopent-3-ene (**68**), its 1,1-difluoro derivative **69**, and silacyclopent-2-ene (**70**) have strictly planar equilibrium ring conformations.^{65,90,96,282-285} In silacyclopentane (**50**) the high barrier to pseudorotation coupled with a C₂ equilibrium conformation indicates⁶⁵ that the torsional barrier to rotation about CH₂-SiH₂ ring bonds is considerably lower than that for -CH₂-CH₂- ring bonds, and thus the *D*₁ term for **68** is less negative than in **65**. Further, Laane suggests that d- π bonding between Si and C atoms makes an additional positive contribution to the *B*₁ term of eq 20, which taken with positive *B*₀ and *E*₁ values is sufficient to overcome the attenuated negative *D*₁ term. Consequently *B* is positive and the ring is planar at equilibrium.

TABLE XII. Five-Membered Rings with One Endocyclic Double Bond and Three Endocyclic Methylene Groups

molecule	equilibrium conformation	source of data ^b	ring-puckering potential function ^a				molecular geometry					
			ref	barrier to planar ring, cm ⁻¹	dihedral angle ^c (α), deg	notes	method ^b	ref	type ^d	dihedral angle ^c (α), deg	notes	other ref
 65	puckered, C _s	MW	270	232	-	<i>e</i>	MW	270	<i>r</i> ₀	22.3	<i>f</i>	105 (MIRC), 271 (R)
		MW	57	250-400	-	<i>g</i>	ED	272	<i>r</i> _a	29		273 (R), 274 (R, VA)
		FIR	12	232 ± 5	23.3	<i>h</i>						275 (R), 276 (VA)
		MW	49	232 ± 5	-	<i>h, i</i>						
		MIRC	36	245	22.1	<i>h</i>						
		FIR, R	277	215 (<i>d</i> ₈ species)	26.5 (av)	<i>h</i>						
 66	puckered, C _s	FIR, R	278	231 (<i>d</i> ₁), 224 (<i>d</i> ₄)	25.9 (av)	<i>h</i>						
		FIR, R	279	232 ± 5		<i>h, j</i>	ED	280	<i>r</i> _g	21.9 ± 0.5		274 (VA)
 67	puckered, C _s	FIR, MIRC	281	113 ± 5	19.7 ± 1.0	<i>h</i>						
 68	planar, C _{2v}	FIR	65	0	0	<i>h</i>	ED	282	<i>r</i> _a	15.7 ± 7.7		283 (VA), 96 (R)
		MIRC	90	0	0	<i>h</i>						
 69	planar, C _{2v}						MW	284	(<i>r</i> ₀)	0	<i>k</i>	283 (VA)
 70	planar, C _s	FIR	285	0	0	<i>h</i>						90 (VA)

^a PE function of the reduced type $V(z) = az^4 + bz^2$ unless otherwise noted. ^b See section V.A for list of abbreviations. ^c See Figure 1 for definition. ^d See text for discussion of geometry type. ^e Vibrational separations from MW relative intensity measurements fitted to $V(z) = az^2 + b \exp(-cz^2)$. ^f Several geometric parameters assumed. ^g $\nu = 1 \leftarrow 0$ separation from Coriolis interaction in rotational spectra of $\nu = 0$ and 1 states of puckering mode. ^h Model of motion assumed in deriving α from z . ⁱ Variation of rotational constants with ring-puckering quantum number used to determine PE function. ^j Model discussed in which CH₂ rocking and ring-puckering mode are allowed to mix. ^k Assumed geometry consistent with observed rotational constants.

b. Two Endocyclic Methylene Groups

No geometrical details are available for molecules of this type, and hence only details of the ring-puckering potential function are given in Table XIII.

Azacyclopent-3-ene (2,5-dihydropyrrole, **71**) is puckered at equilibrium^{20,102,288} while oxacyclopent-3-ene^{17,28,28,36} (2,5-dihydrofuran, **72**) and its thia analogue **73**^{36,40,287} are planar. The order of the barrier height to planarity is **65** > **71** > **72**, which can be understood in terms of a less negative contribution D_t to B_t of eq 21 along the series. This in turn results from the order X = CH₂ > NH > O for the barrier to torsional motion about the C-X ring bonds. In the case of **72**, the term $E_t + B_d$ is greater in magnitude than D_t so that the barrier is zero. A similar result holds for **73**.

Oxacyclopent-2-ene^{36,41,288,289} (2,3-dihydrofuran, **74**), its 2-methyl derivative²⁸ **75**, and its thia analogue^{36,288} **76** are all puckered at equilibrium, in contrast to **72** and **73** which have the double bond in the 3-position and are planar. This result can be rationalized if a pair of adjacent methylene groups in **74**, **75**, and **76** leads to a more negative D_t than is the case when a heteroatom separates the methylene groups as in **72** and **73**. The increase in barrier from **74** to **76** is similar to that between oxetane and thietane. The planar equilibrium conformation²⁹⁰ found for 2-oxazoline (**77**) represents a decrease of the barrier to the planar ring from the isoelectronic **74**, a result which is consistent with the decrease in this quantity from cyclopentene (**65**) to pyrazoline (**67**).

2. Three Endocyclic Trigonal Carbon Atoms

Molecules of this type (see Table XIV) have an endocyclic

trigonal carbon atom in addition to the two already present by virtue of the double bond in compounds **65** to **77**. Angle strain in the planar ring is thereby increased, and an increased term B_d in eq 20 is expected.

a. Two Endocyclic Methylene Groups

Cyclopent-3-enone (**78**) has a planar ring at equilibrium and the puckering mode is governed by an essentially harmonic potential function.^{48,52,86,291} Since there are no adjacent CH₂ groups in **78**, $D_t = 0$ and only the positive term E_t contributes to B_t in eq 21, so that $B = B_d + B_t$ will be large and positive—hence the quadratic nature of the function. In cyclopent-2-enone (**79**), on the other hand, the CH₂ groups are adjacent and allow a contribution D_t to the B_t term. The term B_d and the contribution from conjugation are nevertheless sufficient to hold the CH₂ groups eclipsed in the planar equilibrium conformation and to ensure an essentially harmonic puckering mode.²⁹²⁻²⁹⁴







b. Less Than Two Endocyclic Methylene Groups

Like **79**, oxacyclopent-3-en-2-one (γ -crotonolactone, **80**) is planar,²⁸³ but replacement of a CH₂ by O presumably leads to a less negative D_t term and hence a more nearly harmonic ring-puckering mode.²⁹⁵ 1,3-Dioxacyclopent-4-en-2-one (vinylene carbonate,²⁹⁶⁻²⁹⁸ **81**) and 1,3,4-oxathiazacyclopent-5-en-2-one²⁹⁹ (**82**) are also rigidly planar.

3. Four Endocyclic Trigonal Carbon Atoms







Ring angle strain is now predominant. Hence cyclopent-4-ene-1,3-dione³⁰⁰⁻³⁰² (**83**) and maleic anhydride³⁰³⁻³⁰⁵ (**84**) are

TABLE XIII. Five-Membered Rings with One Endocyclic Bond and Two Endocyclic Methylene Groups

molecule	equilibrium conformation	ring-puckering potential function ^a				notes	other ref
		source of data ^b	ref	barrier to planar ring, cm ⁻¹	dihedral angle ^c (α), deg		
 71	puckered, C _s	FIR	20	55	-	<i>d, e, f</i>	102 (R) 286 (MW)
 72	planar, C _{2v}	FIR FIR FIR	17 28 26	0 0 0	0 0 0	<i>e</i> <i>e</i> <i>g</i>	36 (MIRC)
 73	planar, C _{2v}	MIRC FIR, MIRC	36 40	0 0	0 0	<i>e</i> <i>e</i>	287 (VA)
 74	puckered, C ₁	MIRC FIR MW	36 41 289	87 83 83	- ~19 19	<i>e</i> <i>e</i> <i>e, h</i>	288 (R)
 75	puckered, C ₁	FIR	28	98		<i>e</i>	
 76	puckered, C ₁	MIRC R	36 288	206 325	- 28 ± 3	<i>e, i</i> <i>e</i>	
 77	planar, C _s	FIR, MW, R	290	0	0	<i>e</i>	

^a PE function of reduced type $V(z) = az^4 + bz^2$ unless otherwise noted. ^b See section V.A for list of abbreviations. ^c See Figure 1 for definition. ^d PE function $V(z) = az^4 + bz^2 + cz^3$ used. ^e Model of motion used to derive $V(x)$ from $V(z)$. ^f Energy difference of 45 cm⁻¹ between axial and equatorial conformers. ^g Two-dimensional potential function used to fit ring-puckering progressions based on $\nu_T = 0$ and $\nu_T = 1$ of the ring-twisting mode. ^h Vibrational spacings in the ring-puckering mode from relative intensity measurements in MW spectrum. FIR assignment of ref 41 confirmed but not that in ref 36. ⁱ Term $c \exp(-dz^2)$ included in $V(z)$.

TABLE XIV. Molecules with One Endocyclic Double Bond but Three and Four Endocyclic Trigonal Carbon Atoms

molecule	equilibrium conformation	ring-puckering potential function ^a				notes	molecular geometry			other ref
		source of data ^b	ref	barrier to planar ring, cm ⁻¹	method		ref	type ^c		
 78	planar, C _{2v}	FIR, MW, R FIR	52 66	0 0		<i>d</i>	MW	48	<i>r_s</i>	291 (VA)
 79	planar, C _s	FIR MW	292 293, 294	0 0		<i>e</i>				
 80	planar, C _s	MW	263, 295	0		<i>e</i>				
 81	planar, C _{2v}	MW FIR	296 298	0 0		<i>e</i> <i>f</i>	MW	297	<i>r_s</i>	
 82	planar, C _s						MW, ED	299	<i>r_α^u</i>	
 83	planar, C _{2v}	MW	300	0			ED	301	<i>r_a</i>	302 (VA)
 84	planar, C _{2v}						ED MW	303 305	<i>r_g</i> <i>r_s</i>	304 (VA)

^a PE function of the type $V(z) = az^4 + bz^2$ unless otherwise noted. ^b See section V.A for list of abbreviations. ^c See text for discussion of geometry type. ^d $V(x)$ also derived by using a calculated reduced mass. ^e Only qualitative information about PE function available from variation of rotational constants with ring-puckered quantum number. ^f Fundamental and hot bands of ring-puckering mode unresolved. Mode taken as harmonic.

TABLE XV. Five-Membered Rings with Two Endocyclic Double Bonds. Monohetero Analogues of Cyclopentadiene



85

molecule	substituents ^a in 85		point group	molecular geometry		other ref ^d	
	endocyclic	exocyclic		method ^b	type ^c		ref
cyclopentadiene			C_{2v}	MW	r_s	307, 308	309, 310 (VA)
perchlorocyclopentadiene	$CCl_2(1)$	$Cl(2, 3, 4, 5)$	C_{2v}	ED	r_g	311	
2-cyanocyclopentadiene		$CN(2)$	C_s	MW	(r_o)	312	
cyclopentadienone	$C=O(1)$		C_{2v}	MW		313	
fulvene	$C=CH_2(1)$		C_{2v}	MW	r_s	314, 315	316 (MW), 317, 318 (VA)
6,6-dimethylfulvene	$C=C(CH_3)_2(1)$		$C_{2v}(\text{ass})$	ED	r_a	319	
hexachlorofulvene	$C=CCl_2(1)$	$Cl(2, 3, 4, 5)$	C_{2v}	ED	r_a	320	
6-hydroxy-2-formylfulvene	$C=CHOH(1)$	$CHO(2)$	C_s	MW	(r_o)	321	
pyrrole	$NH(1)$		C_{2v}	MW	r_s	322	323 (MW)
cis-pyrrole-2-carboxaldehyde	$NH(1)$	$CHO(2)$	C_s	MW	(r_o)	324	
furan	$O(1)$		C_{2v}	MW	r_s	325, 326	
2-methylfuran	$O(1)$	$CH_3(2)$	C_s	MW	(r_o)	327	
3-methylfuran	$O(1)$	$CH_3(3)$	C_s	MW	(r_o)	328	
2-cyanofuran	$O(1)$	$CN(2)$	C_s	MW	(r_o)	329, 330	
thiophene	$S(1)$		C_{2v}	MW	r_s	331	332 (MW)
				MW	r_g, r_a	333, 334	
3-methylthiophene	$S(1)$	$CH_3(3)$	C_s	MW	(r_o)	335	336 (MW)
2-chlorothiophene	$S(1)$	$Cl(2)$	C_s	ED	r_a	334, 337, 338	
				MW	(r_o)	339	
2-bromothiophene	$S(1)$	$Br(2)$	C_s	ED	r_a	344, 337, 338	340 (MW)
2-cyanothiophene	$S(1)$	$CN(2)$	C_s	MW	(r_o)	341	
3-cyanothiophene	$S(1)$	$CN(3)$	C_s	MW	(r_o)	342	
2-nitrothiophene	$S(1)$	$NO_2(2)$	C_s	MW		343	
3-nitrothiophene	$S(1)$	$NO_2(3)$	C_s	MW		344	
2-thiophenecarboxaldehyde	$S(1)$	$CHO(2)$	C_s	MW	(r_o)	345	
selenophene	Se		C_{2v}	MW	r_s	346	347 (MW)
tellurophene	Te		C_{2v}	MW	(r_o)	348	

^a Numbers in parentheses refer to positions of substituents in 85. ^b See section V.A for list of abbreviations. ^c See text for discussion of geometry type. (r_o) indicates geometrical parameters consistent with ground-state rotational constants but not unique. ^d References with information implying conformation or geometry.

planar and offer considerable resistance to the ring-puckering motion (see Table XIV). The dichloro analogue of **84** is probably planar³⁰⁶ also.

E. Five-Membered Rings with Two Endocyclic Double Bonds

All molecules with two endocyclic double bonds discussed under this heading have cyclopentadiene (**85**) as a precursor. The derivatives can be viewed as formed from **85** by replacing the CH_2 group (1-position) either by NH , O , S , Se , or Te or by a trigonal carbon atom carrying another group (e.g., $C=CH_2$, $C=O$, etc.). In some cases further substitution of N atoms for CH groups at one or more positions 2 to 5 is involved.

The presence of two endocyclic double bonds imposes a rigidly planar equilibrium conformation on these five-membered rings. The high angle strain in the planar ring implied by four (or five) trigonal carbon or nitrogen atoms together with the possibility of π -electron conjugation leads to a large positive B_d term in eq 20. Moreover, the absence of adjacent methylene groups means that the B_i term cannot be negative. Thus a planar ring with high-frequency out-of-plane ring modes essentially quadratic in the out-of-plane displacement coordinates is to be expected.

Mainly as a result of their rigidity, molecules in this class have been investigated in considerable geometrical detail. In Table XV are given the molecular point group, the type of detailed geometry, and references for **85** and its monohetero analogues³⁰⁷⁻³⁴⁸ (a trigonal carbon atom at position 1 is taken as a heteroatom). Also included are references which do not allude explicitly to geometry but which imply conclusions about conformation. Table XVI similarly deals with di-, tri-, and tetrahetero analogues³⁴⁹⁻³⁸⁷ of **85**.

VI. Conformations of Four- and Five-Membered Rings in Bicyclic and Polycyclic Compounds

A. Introduction

When four- and five-membered rings occur in fused polycyclic molecules their equilibrium conformation can be constrained to be quite different from that adopted in the free molecule. Except in a few of the cases to be discussed here, the rings are rigidly held in the polycyclic compound, and, while this aids detailed geometrical investigation, low-frequency ring-puckering modes are not generally observed. For convenience, bicyclic compounds containing four-membered rings are discussed separately in B below, those containing five-membered rings are dealt with in C, while polycyclic systems containing four- and/or five-membered rings are encountered under D.

B. Bicyclic Compounds Containing Four-Membered Rings

It is convenient to consider conformation of a four-membered ring in a bicyclic compound in relation to that in the monocyclic precursor. Thus in Table XVII are given the monocyclic precursor, the operation required to generate the bicyclic molecule from it, and some details of the molecular geometry that results. Ring-puckering vibrations have not been studied for molecules recorded in Table XVII.















Bicyclo[2.1.0]pentane (**86**), the simplest bicyclic molecule containing a four-membered ring, can be viewed as formed by linking the 1,2-positions of cyclobutane by means of a CH_2 group. The effect of this is to allow the heavy atoms in the four-membered ring to achieve a planar equilibrium conformation, ^{386,389} in much the same way that the double bond confers

TABLE XVI. Five-Membered Rings with Two Endocyclic Double Bonds. Di-, Tri-, and Tetrahetero Analogues of Cyclopentadiene (85)

molecule	endocyclic ^a substituents in 85	point group	molecular geometry			other ref ^d
			method ^b	type ^c	ref	
pyrazole	NH(1), N(2)	C_s	MW	r_s	349	350, 351 (MW)
imidazole	NH(1), N(3)	C_s	-	-	-	352, 353 (MW)
oxazole	O(1), N(3)	C_s	MW	r_s	354	355 (MW), 356 (VA)
isoxazole	O(1), N(2)	C_s	MW	r_s	357, 358	
thiazole	S(1), N(3)	C_s	MW	r_s	359	356 (VA)
isothiazole	S(1), N(2)	C_s	-	-	-	353 (MW), 360 (VA)
1,2,4-oxadiazole	O(1), N(2), N(4)	C_s	-	-	-	353 (MW), 361 (VA)
1,2,5-oxadiazole	O(1), N(2), N(5)	C_{2v}	MW	r_s	362	363, 364, 365, 366 (VA)
1,3,4-oxadiazole	O(1), N(3), N(4)	C_{2v}	MW	r_s	367	366, 368, 369 (VA)
1,2,3-thiadiazole	S(1), N(2), N(3)	C_s	MW	r_s	370	
1,2,4-thiadiazole	S(1), N(2), N(4)	C_s	MW	r_s	371	
1,2,5-thiadiazole	S(1), N(2), N(5)	C_{2v}	MW	r_s	372	366, 374
			ED	r_g	373	
1,3,4-thiadiazole	S(1), N(3), N(4)	C_{2v}	MW	r_s	375	377 (MW), 378, 379 (VA)
			ED	r_α	376	
1,2,5-selenadiazole	Se(1), N(2), N(5)	C_{2v}	MW	r_o	380	381 (VA)
1,3,4-selenadiazole	Se(1), N(3), N(4)	C_{2v}	MW	(r_o)	382	
1,2,3-triazole	NH(1), N(2), N(3)	C_s	MW	(r_o)	383 ^e	384 (MW)
1,2,4-triazole	NH(1), N(2), N(4)	C_s	ED	r_a	385	
			MW	(r_o)	386 ^f	
tetrazole	NH(1), N(2), N(3), N(4)	C_s	MW	-	387 ^g	

^a Numbers in parentheses refer to positions of substituents in 85. ^b See section V.A for list of abbreviations. ^c See text for discussion of geometry type. (r_o) indicates geometrical parameters consistent with ground-state rotational constants but not unique. ^d References with information implying conformation or geometry. ^e 1H tautomer identified. ^f 1H tautomer identified. Symmetrical (C_{2v}) tautomer with NH at 4 position not observed. ^g Evidence for mixture of 1H and 2H tautomers in vapor phase.

TABLE XVII. Bicyclic Hydrocarbons Containing Four-Membered Rings

monocyclic precursor	bicyclic generator	bicyclic molecule	point group	molecular geometry of bicyclic compound				notes
				method ^a	ref	type ^b	dihedral angle ^c (α), deg	
	1,2-methylene bridge		C_s	MW	388	r_s	0	d
				ED	389	r_g	0	
	3,4-methylene bridge		C_s	MW	390	r_o	0	e
				ED	391	r_g	0	
	1,3-methylene bridge		D_{3h}	ED	392	r_a	60	
	1,2-dimethylene bridge		C_2 (ass)	ED	394	r_a	11.5 ± 1.8	f
	3,4-ethylene bridge		C_{2v}	ED	395	r_a	0	g
				MW	396	r_o	0	
	1,3-dimethylene bridge		C_{2v}	ED	399	r_a	55 ± 2	
	1,3-ethylene bridge		C_{2v}	MW	400	r_s	53.3 ± 0.2	
				ED	401	r_a	56.5 ± 1.2	
				ED	402	r_a	53.5	

^a See section V.A for list of abbreviations. ^b See text for discussion of geometry type. ^c Angle of puckering of four-membered ring(s) as defined in Figure 1. ^d Dihedral angle between 3- and 4-membered rings 67.3 ± 0.2 and $71.6 \pm 0.4^\circ$ from MW and ED methods, respectively. ^e Dihedral angle between planes of rings is 66 and 65.5° from the MW and ED methods, respectively. ^f $C_2C_1C_6$ angle = $113.5 \pm 1.1^\circ$. ^g Angle between 4-membered rings is 117.3 ± 0.7 and $117 \pm 5^\circ$ from ED and MW methods, respectively.

planarity on cyclobutene. The angle between the two rings of **86** results in staggering of adjacent C-H bonds. A similar operation on cyclobutene gives bicyclo[2.1.0]pent-2-ene (**87**), which has a similar arrangement of the rings.^{390,391}









Linking the 1,3-positions of cyclobutane by a CH_2 group leads to bicyclo[1.1.1]pentane (**88**) in which D_{3h} molecule the cyclobutane rings are all puckered to a greater extent than in the free molecule and the C-H bonds are all staggered.³⁹² The 1-chloro derivative of **88** has C_{3v} symmetry.³⁹³

Bicyclo[2.2.0]hexane (**89**) is generated when a CH_2-CH_2 group links the 1,2-positions of cyclobutane. This constraint allows only a small degree of puckering of the four-membered rings.³⁹⁴ On the other hand, the chemically interesting relative

of **89**, bicyclo[2.2.0]hexa-2,5-diene (**90**), has the rings planar^{395,396} but with an angle between them similar to that in **89**. The conformations of the hexafluoro³⁹⁷ and hexamethyl³⁹⁸ analogues are similar to that of **90**.

When the 1,3-positions of cyclobutane are linked by CH_2-CH_2 and $CH=CH$ bridges to give bicyclo[2.1.1]hexane³⁹⁹ (**91**) and bicyclo[2.1.1]hex-2-ene⁴⁰⁰⁻⁴⁰² (**92**), respectively, the angle of puckering of the four-membered ring increases to $\sim 55^\circ$ in both cases while the atoms in and terminating the bridge are coplanar. The 5-thia analogue of **91** has the thietane ring more puckered than in the parent compound.⁴⁰³ Ground-state rotational constants are available for the derivatives of **91** having $C=O$ substituted at the 2-position⁴⁰⁴ and also at the 5-position.⁴⁰⁵

TABLE XVIII. Bicyclic Compounds Containing Five-Membered Rings Fused to Three- and Four-Membered Rings

molecule	equilibrium conformation	ring-puckering potential function ^a		molecular geometry					
		source of data ^b	ref	method ^b	ref	type ^c	angles, ^d deg		notes
							ϕ	τ	
 93	boat-like, C_s	FIR	406	MW	407	r_o	35	64 (ass)	<i>e</i>
		R	408	ED	409	r_g	23.8 ± 4.6	71.4 ± 1.4	
				MW + ED	409	r_g	25.2 ± 2.8	70.6 ± 1.1	
 94	boat-like, C_s	FIR	406	MW	410	r_o	42	64 (ass)	<i>e</i>
		R	408						
 95	boat-like, C_s	FIR	406	MW	411	r_o	30	64 (ass)	<i>e, f</i>
		R	408	MW + ED	412	r_g	27.7 ± 2.1	75.3 ± 1.0	
 96	boat-like, C_s	FIR	406	MW	413	r_o	40 ± 10	64 (ass)	<i>e</i>
		R	408						
 97	boat-like, C_s			MW	414	r_o	30 ± 5	65 ± 5	<i>e</i>
 98	boat-like, C_s	FIR	415	MW	415	r_s	18.8 ± 0.1	66.9 ± 0.3	
 99		-	-	MW	417	r_s, r_o	g	66.5 ± 1	
 100	boat-like, C_s	FIR, R	418	ED	419	r_a	-	-	<i>h</i>
					MW	420	-	-	
 101	boat-like, C_s	FIR, R	418						

^a PE function of reduced type $V(z) = az^4 + bz^2 + cz^3$ with single minimum determined in each case. ^b See section V.A for list of abbreviations. ^c See text for discussion of geometry type. ^d See Figure 15 for definition of angles. ^e ϕ fitted to rotational constants. All other parameters assumed. ^f Electric dipole moment used to obtain ϕ . ^g Five-membered ring nearly planar. ^h MW results consistent with boat-like conformer, ED results interpreted in favor of chair-like form.

C. Bicyclic Compounds Containing Five-Membered Rings

The simplest bicyclic molecule containing a five-membered ring is bicyclo[3.1.0]hexane (**93**), which may be viewed as formed by linking the 1,2-positions of cyclopentane with a CH_2 group. **93** and molecules based on it can be considered as essentially pseudo-four-membered rings, with the bridging group fulfilling the same role as the double bond in cyclopentene, that is, raising the resistance to torsional motion about the ring bond in question. The puckering mode of the five-membered ring in **93** is analogously much lower in frequency than the twisting mode and consequently the one-dimensional approximation is also applicable in this case. Of course, the puckering mode is now unsymmetrical in the reduced coordinate z .

As a result of their pseudo-four-membered character, **93**, its 3-oxa, 6-oxa, 3,6-dioxa, 6-thia, and 3-keto analogues (**94**, **95**, **96**, **97**, and **98**, respectively) have been extensively investigated⁴⁰⁸⁻⁴¹⁵ by the far-infrared, microwave, and Raman spectroscopic and electron-diffraction techniques, with the results summarized in Table XVIII. In the case of each of **93** to **98** only one conformer, the boatlike, could be identified and in all but **97** the ring-puckering mode is of the single-minimum type showing an inflection. From Table XVIII it is clear that the boatlike forms have similar angles τ and ϕ , as defined in Figure 15, with the exception of **98**. The additional strain imposed on the five-membered ring by substitution of CH_2 by $\text{C}=\text{O}$ favors the planar ring in this case and ϕ is reduced. The epimers thujone and isothujone, both of which are bicyclic monoterpenes derived from **98** by substituting isopropyl and methyl at the 1



Figure 15. Definition of the dihedral angles τ and ϕ for molecules based on the bicyclo[3.1.0]hexane skeleton.



and 4 positions, respectively, have been shown⁴¹⁶ to have ring conformations similar to that of **98**. On the other hand, when a double bond is placed in the five-membered ring of **93** to give bicyclo[3.1.0]hex-2-ene (**99**), the two endocyclic trigonal carbon atoms now hold the ring essentially planar⁴¹⁷ (see Table XVIII).

Although bicyclo[2.1.1]hexane (**91**) contains a five-membered ring and can be viewed as generated from cyclopentane by bridging the 1,3-positions by a CH_2 group, it has been discussed in B above because it also contains a four-membered ring.³⁹⁹

If the 1,2-positions of cyclopentane are linked with an ethylene group, bicyclo[3.2.0]hept-6-ene⁴¹⁸⁻⁴²⁰ (**100**) results. The endocyclic double bond confers rigidity on the four-membered ring so that, as in **93**, the puckering mode of the five-membered ring in **100** is the lowest energy mode of the molecule. One-dimensional potential-energy functions for this mode in **100** and its 2-oxa analogue **101** have been determined⁴¹⁸ (see Table XVIII).



















The final group of bicyclic compounds containing five-membered rings considered here⁴²¹⁻⁴³¹ are those based on bicyclo[2.2.1]heptane (norbornane, **102**). This molecule, which is generated by a dimethylene linkage of the 1,3-positions in cyclopentane, and the related hydrocarbons bicyclo[2.2.1]hept-2-ene (norbornene, **103**) and bicyclo[2.2.1]hepta-2,5-diene

TABLE XIX. Bicyclic Molecules Containing Two Fused Five-Membered Rings

parent	substituent	molecular geometry						other ref
		point group	method ^a	ref	type ^b	angle ^c (β), deg	notes	
								
102		C_{2v}	ED	421	r_g	113.1 ± 1.8		422 (ED)
102	1,4-Cl ₂	C_{2v}	ED	423	r_a	108.1 ± 1.8		
102	1-Si	C_8	MW	424	r_o		<i>d</i>	
102	1-CH ₃ -1-Si	C_8	ED	425	r_a	108.1 ± 1.8		
102	7-O	C_{2v}	ED	426	r_g	113.5 ± 0.8		
			MW	427	r_s	113.1 ± 0.5		
102	7-S	C_{2v}	ED	403	r_g	115.0 ± 1.2		
102	7-C=O	C_{2v}	MW	428	r_o		<i>e</i>	
								
103		C_s	ED, MW	429	r_g	110.8 ± 1.5		
103	2,3-N,N	C_8	MW	430	r_o	108.9 ± 0.8		
			ED	431	r_a	118.2		
103	7-C=O	C_8	MW	428	-			
								
104		C_{2v}	ED	421	r_g	115.6 ± 2.2		422 (ED)

^a See section V.A for list of abbreviations. ^b See text for discussion of geometry type. ^c β is angle between the planes C₁C₂C₃C₄ and C₁C₄C₅C₆ in 102 and correspondingly elsewhere. ^d Rotational constants consistent with assumed geometry. ^e Some geometrical parameters assumed to fit others to rotational constants.

TABLE XX. Some Tri- and Tetracyclic Hydrocarbons and Their Relationship to Bicyclic Precursors

bicyclic precursor	ref for geometry	polycyclic generator	polycyclic molecule	polycyclic molecular geometry					
				point group	method ^a	ref	type	notes	
	388, 389	2,3-methylene bridge		D_{2h} (ass)	ED	432	r_g	<i>b</i>	
			105						
	394	2,6-linkage		C_s	MW	433	r_s	<i>c</i>	
			106						
	394	2,3-dimethylene bridge		C_2	ED	434	r_a	<i>d</i>	
			107						
	407, 409	1,2-methylene bridge		C_2 (ass)	ED	435	r_a	<i>e</i>	
			108						
	417	4,6-ethylene bridge		C_s	ED	436	r_a	<i>f</i>	
			109						
	400-402	5,6-linkage		C_{2v}	MW ED	437 438	r_s r_g	<i>g</i>	
			110						
	399	5,6-dimethylene bridge		D_{2d}	ED	439	r_a	<i>h</i>	
			111						
	421	2,6-linkage		C_{3v}	ED	440	r_g	<i>i</i>	
			112						
	421	2,6- and 3,5-linkages		C_{2v}	ED	441	r_g	<i>i</i>	
			113						

^a See section V.A for list of abbreviations. ^b All C-C bonds assumed equivalent. Four-membered ring is planar. ^c $r(C_1-C_2)$ close to that in precursor. Puckering angle of 4-membered rings is 30.3° . ^d Syn and anti conformers detected. Four-membered rings puckered by $\sim 9^\circ$ (cf. $\sim 11^\circ$ in precursor). ^e C_2 axis through C₁ and midpoint of C₄-C₅. ^f Ten slightly different models consistent with data. Cyclopentene rings puckered by $\sim 18^\circ$. ^g C-C single bond system contracts appreciably on formation of tricyclic molecule. ^h Dihedral angle of four-membered ring unchanged from precursor. ⁱ C₁C₂C₃C₄ angle in precursor effectively unchanged.

(norborene, 104) are rigid enough to encourage detailed geometrical investigation^{421, 422, 429} (see Table XIX). The compounds 102, 103, and 104, the 1,4-dichloro,⁴²³ 1-sila,⁴²⁴ 1-methylsila,⁴²⁵ 7-oxa,^{426, 427} 7-thia,⁴⁰³ and 7-oxa⁴²⁸ analogues of

102, and the 2,3-diaza^{430, 431} and 7-oxo⁴²⁸ analogues of 103 are geometrically similar, with the angle between the C₁C₂C₃C₄ and C₁C₄C₅C₆ planes (or their equivalent) in the range $113 \pm 5^\circ$ (see Table XIX).

D. Tri- and Tetracyclic Compounds Containing Four- and Five-Membered Rings

As with some of the bicyclic molecules, a complete geometrical determination in polycyclic compounds is a formidable task because of either the high degeneracy in the radial distribution curve when the electron-diffraction method is used or the extensive isotopic substitution needed in the microwave spectroscopic technique. Nevertheless sufficient progress has been possible to allow Table XX to be constructed. Again it is advantageous to consider the polycyclic molecule in relation to its bicyclic precursor. For example, tricyclo[2.2.0.0^{2,6}]hexane (**106**) results when the 2,6 positions of **89** are connected by a C-C bond. In Table XX, tricyclo[3.1.0.0^{2,4}]hexane⁴³² (**105**), tricyclo[2.2.0.0^{2,6}]hexane⁴³³ (**106**), tricyclo[4.2.0.0^{2,5}]octane⁴³⁴ (**107**), tricyclo[4.1.0.0^{1,3}]heptane⁴³⁵ (**108**), tricyclo[3.3.0.0^{2,8}]octa-3,6-diene (semibullvalene, **109**), tricyclo[2.1.1.0^{5,6}]hex-2-ene^{437,438} (benzvalene, **110**), tricyclo[3.3.0.0^{2,8}]octane⁴³⁹ (**111**), tricyclo[2.2.1.0^{2,6}]heptane⁴⁴⁰ (nortricyclene, **112**), and tetracyclo[2.2.1.0^{2,6}.0^{3,5}]heptane⁴⁴¹ (quadricyclane, **113**) have thus been related to their precursors and some points of geometrical interest abstracted.

VII. Addendum

Since the submission of the manuscript, several papers pertinent to this review have appeared and are discussed briefly below. The numbers of the section and table to which each paper should be assigned are indicated. This addendum extends coverage of the review from *Chemical Abstracts*, **91**, No. 20, to *Chemical Abstracts*, **92**, No. 17, inclusive (see section I).

Two review papers have recently been published. Carreira, Lord, and Malloy⁴⁴² give an extensively illustrated discussion of the low-frequency vibrations of small (four-, five-, pseudo-four and pseudo-five-membered) ring molecules which encompasses the methods of spectroscopic investigation, the theoretical basis for the interpretation of results and numerous individual cases. An article dealing with molecules having large amplitude motions as investigated by the electron diffraction technique also includes a section on cyclic compounds.⁴⁴³

A. Four-Membered Rings

The far-infrared spectra of a number of methyl derivatives of oxetane (**12**) and thietane (**15**) have been observed and analyzed⁴⁴⁴ to give one-dimensional ring-puckering potential functions. The equilibrium conformation is puckered in each case. Thus, symmetrical potential functions with barriers to the planar ring of 51.1, 46.4, and 300.00 cm⁻¹ have been determined for 2,2-Me₂-**12**, 3,3-Me₂-**12**, and 3,3-Me₂-**15**, respectively, while asymmetric functions characterized by barriers measured from the most stable conformer of 107.5, 98.7, and 341.1 are found for 2-Me-**12**, 3-Me-**12**, and 3-Me-**15**, respectively. An electron diffraction investigation⁴⁴⁵ of 2-Me-**12** is consistent only with a planar or nearly planar *r_a* conformation of the ring. The appropriate locations for substituted oxetanes and thietanes are section V.B.1b and Table III. A detailed analysis of the far-infrared spectrum of methylenecyclobutane (**22**) (section V.B.2a and Table IV) has now been made⁴⁴⁶ and leads to a barrier of 139 cm⁻¹ to the planar ring (cf. ref 39, 45, and 139). In the absence of observed ring-puckering transitions, a quasi-planar ring with a low barrier to the planar conformation in 1,1-dimethylsilacyclobutane (section V.B.1a and Table II) is predicted on the basis of a general vibrational analysis.⁴⁴⁷

B. Five-Membered Rings

A relationship established⁴⁴⁸ between two-dimensional potential functions (in, e.g., ring-puckering and ring-twisting coordinates)

and effective one-dimensional potential functions (in, e.g., the ring-puckering coordinate) allows the former to be determined for a pseudo-four-membered ring if the latter is known. The relationship has been tested for oxacyclopent-3-ene (**72**) (section V.D.1b and Table XIII) and then applied to cyclopentene (**65**) (section V.D.1a and Table XII) to give a two-dimensional potential surface. An analysis⁴⁴⁹ of the dependence of rotational constants and quartic centrifugal distortion constants on the ring-puckering quantum number in 1-pyrazoline (**67**) (section V.D.1a and Table XII) indicates that the potential function preferred for this mode in ref 281 is essentially correct. A further structure of silacyclopentane (**50**) (section V.C.1a and Table IX) determined by the electron diffraction technique has also been reported.⁴⁵⁰

Acknowledgments. I thank Professors D. J. Millen and W. H. Flygare for some helpful suggestions and Catherine Young for producing an excellent typescript.

VIII. References

- (1) S. I. Chan, J. Zinn, and W. D. Gwinn, *J. Chem. Phys.*, **33**, 295 (1960).
- (2) S. I. Chan, J. Zinn, J. Fernandez, and W. D. Gwinn, *J. Chem. Phys.*, **33**, 1643 (1960).
- (3) S. I. Chan, J. Zinn, and W. D. Gwinn, *J. Chem. Phys.*, **34**, 1319 (1961).
- (4) S. I. Chan, T. R. Borgers, J. W. Russell, H. L. Strauss, and W. D. Gwinn, *J. Chem. Phys.*, **44**, 1103 (1966).
- (5) R. P. Bell, *Proc. R. Soc., London, Ser. A*, **183**, 328 (1945).
- (6) J. E. Kilpatrick, K. S. Pitzer, and R. Spitzer, *J. Am. Chem. Soc.*, **69**, 2483 (1947).
- (7) D. O. Harris, G. G. Engerholm, C. A. Tolman, A. C. Luntz, R. A. Keller, H. Kim, and W. D. Gwinn, *J. Chem. Phys.*, **50**, 2438 (1969).
- (8) G. G. Engerholm, A. C. Luntz, W. D. Gwinn, and D. O. Harris, *J. Chem. Phys.*, **50**, 2446 (1969).
- (9) G. Herzberg, "Molecular Spectra and Molecular Structure", Vol. III of "Electronic Spectra and Electronic Structure of Polyatomic Molecules", Van Nostrand, Princeton, NJ, 1966, p. 2.
- (10) The Born-Oppenheimer approximation is assumed to hold, and the variation of the electronic energy with the relative positions of the nuclei defines the potential energy.
- (11) W. D. Gwinn and A. S. Gaylord, *MTP Int. Rev. Sci.: Phys. Chem.*, Ser. Two, **3**, 205 (1973).
- (12) J. Laane and R. C. Lord, *J. Chem. Phys.*, **47**, 4941 (1967).
- (13) J. Laane, *Appl. Spectrosc.*, **24**, 73 (1970).
- (14) C. S. Blackwell and R. C. Lord in "Vibrational Spectra and Structure", Vol. 1, J. R. Durig, Ed., Marcel Dekker, New York, 1972, p. 1.
- (15) J. S. Gibson and D. O. Harris, *J. Chem. Phys.*, **57**, 2318 (1972).
- (16) D. O. Harris, H. W. Harrington, A. C. Luntz, and W. D. Gwinn, *J. Chem. Phys.*, **44**, 3467 (1966).
- (17) T. Ueda and T. Shimanouchi, *J. Chem. Phys.*, **47**, 4042 (1967).
- (18) J. Laane and R. C. Lord, *J. Chem. Phys.*, **48**, 1508 (1968).
- (19) W. G. Rothschild, *J. Chem. Phys.*, **45**, 1214 (1966).
- (20) L. A. Carreira and R. C. Lord, *J. Chem. Phys.*, **51**, 2735 (1969).
- (21) See ref 18, for example.
- (22) (a) J. Laane, "Vibrational Spectra and Structure", Vol. 1, J. R. Durig, Ed., Marcel Dekker, New York, 1972, p. 25; (b) J. D. Lewis, T. B. Malloy Jr., T. H. Chao, and J. Laane, *J. Mol. Struct.*, **12**, 427 (1972).
- (23) T. Ikeda, R. C. Lord, T. B. Malloy Jr., and T. Ueda, *J. Chem. Phys.*, **58**, 1434 (1972).
- (24) R. Davidson and P. A. Warsop, *J. Chem. Soc., Faraday Trans. 2*, **68**, 1875 (1972).
- (25) L. A. Carreira, G. J. Jlang, W. B. Person, and J. N. Willis Jr., *J. Chem. Phys.*, **58**, 1440 (1972).
- (26) L. A. Carreira, I. M. Mills, and W. B. Person, *J. Chem. Phys.*, **58**, 1444 (1972).
- (27) See ref 29 and 30 for a discussion of shapes of Q branches.
- (28) L. A. Carreira and R. C. Lord, *J. Chem. Phys.*, **51**, 3225 (1969).
- (29) J. Jokisaari and J. Kauppinen, *J. Chem. Phys.*, **59**, 2260 (1973).
- (30) T. R. Borgers and H. L. Strauss, *J. Chem. Phys.*, **45**, 947 (1966).
- (31) J. A. Greenhouse and H. L. Strauss, *J. Chem. Phys.*, **50**, 124 (1969).
- (32) J. R. Durig and D. W. Wertz, *J. Chem. Phys.*, **49**, 2118 (1968).
- (33) K. M. Ewool and H. L. Strauss, *J. Chem. Phys.*, **64**, 2697 (1976).
- (34) J. Laane, *J. Chem. Phys.*, **50**, 1946 (1969).
- (35) J. R. Durig, W. J. Natter, and V. F. Kalasinsky, *J. Chem. Phys.*, **67**, 4756 (1977).
- (36) T. Ueda and T. Shimanouchi, *J. Chem. Phys.*, **47**, 5018 (1967).
- (37) A. B. Harvey, J. R. Durig, and A. C. Morrissey, *J. Chem. Phys.*, **47**, 4865 (1967).
- (38) T. Ueda and T. Shimanouchi, *J. Chem. Phys.*, **49**, 470 (1968).
- (39) T. B. Malloy Jr., F. Fisher, and R. M. Hedges, *J. Chem. Phys.*, **52**, 5325 (1970).
- (40) W. H. Green and A. B. Harvey, *J. Chem. Phys.*, **49**, 177 (1968).
- (41) W. H. Green, *J. Chem. Phys.*, **50**, 1619 (1969).
- (42) H. Wieser and R. A. Kydd, *J. Raman Spectrosc.*, **4**, 401 (1976).
- (43) I. M. Mills and J. M. R. Stone, *Mol. Phys.*, **18**, 631 (1970).
- (44) F. A. Miller and R. J. Capwell, *Spectrochim. Acta, Part A*, **27**, 947 (1971).

- (45) J. R. Durig, A. C. Shing, L. A. Carreira, and Y. S. Li, *J. Chem. Phys.*, **57**, 4398 (1972).
- (46) H. Wieser, M. Danyluk, W. Kiefer, and H. J. Bernstein, *Can. J. Chem.*, **50**, 2771 (1972).
- (47) W. Kiefer, H. J. Bernstein, M. Danyluk, and H. Wieser, *Chem. Phys. Lett.*, **12**, 605 (1972).
- (48) J. W. Bevan and A. C. Legon, *J. Chem. Soc., Faraday Trans. 2*, **69**, 902 (1973).
- (49) L. H. Scharpen, *J. Chem. Phys.*, **48**, 3552 (1968).
- (50) R. A. Creswell and I. M. Mills, *J. Mol. Spectrosc.*, **52**, 392 (1974).
- (51) P. D. Mallinson and A. G. Robiette, *J. Mol. Spectrosc.*, **52**, 413 (1974).
- (52) J. W. Bevan and A. C. Legon, *J. Chem. Soc., Faraday Trans. 2*, **69**, 916 (1973).
- (53) W. Gordy and R. L. Cook, *Tech. Org. Chem.*, **9** (2), 525 (1970).
- (54) C. C. Costain, *J. Chem. Phys.*, **29**, 864 (1958).
- (55) J. Kraitchman, *Am. J. Phys.*, **21**, 17 (1953).
- (56) J. K. G. Watson, *J. Mol. Spectrosc.*, **48**, 479 (1973).
- (57) S. S. Butcher and C. C. Costain, *J. Mol. Spectrosc.*, **15**, 40 (1965).
- (58) D. R. Lide, *J. Mol. Spectrosc.*, **8**, 142 (1962).
- (59) See, for example L. S. Bartell, *Tech. Chem. (N.Y.)*, **1**, (3D), 125 (1972).
- (60) K. Kuchitsu and S. J. Cyvin in "Molecular Vibrations and Structure", S. J. Cyvin, Ed., Elsevier, Amsterdam, 1972, Chapter 12.
- (61) A. G. Robiette in "Molecular Structure by Diffraction Methods", Specialist Periodical Reports of the Chemical Society, Vol. 1, The Chemical Society, London, 1972, Chapter 4.
- (62) K. Hedberg in "Critical Evaluation of Chemical and Physical Structural Information", D. R. Lide, Jr., and M. A. Paul, Ed., National Academy of Sciences, Washington D.C., 1974, p 77.
- (63) K. Kuchitsu, *MTP Int. Rev. Sci.: Phys. Chem. Ser. One*, **2**, 203 (1972).
- (64) K. Karakida and K. Kuchitsu, *Bull. Chem. Soc. Jpn.*, **48**, 1691 (1975).
- (65) J. Laane, *J. Chem. Phys.*, **50**, 776 (1969).
- (66) J. D. Lewis and J. Laane, *J. Mol. Spectrosc.*, **53**, 417 (1974).
- (67) A. L. Meinzer and W. C. Pringle, *J. Phys. Chem.*, **80**, 1178 (1976).
- (68) E. Hirota, C. Matsumura, and Y. Morino, *Bull. Chem. Soc. Jpn.*, **40**, 1124 (1967).
- (69) J. D. Swalen and C. C. Costain, *J. Chem. Phys.*, **31**, 1562 (1959).
- (70) D. R. Lide, *J. Chem. Phys.*, **33**, 1514 (1960).
- (71) J. E. Wollrab and V. W. Laurie, *J. Chem. Phys.*, **48**, 5058 (1969).
- (72) U. Blukis, P. H. Kasai, and R. J. Myers, *J. Chem. Phys.*, **38**, 2753 (1963).
- (73) J. E. Wollrab and V. W. Laurie, *J. Chem. Phys.*, **54**, 537 (1971).
- (74) Landolt-Börnstein, "Numerical Data and Functional Relationships in Science and Technology", Group II, Vol. 7, "Structure Data of Free Polyatomic Molecules", J. H. Callomon, E. Hirota, K. Kuchitsu, W. J. Lafferty, A. G. Maki, and C. S. Pote, Eds., Springer-Verlag, Heidelberg, 1976.
- (75) T. B. Malloy, Jr., and W. J. Lafferty, *J. Mol. Spectrosc.*, **54**, 20 (1975).
- (76) H. Kambara, K. Kuchitsu, Y. Morino, unpublished work referred to in ref 63.
- (77) F. A. Miller, R. J. Capwell, R. C. Lord, and D. G. Rea, *Spectrochim. Acta, Part A*, **28**, 603 (1972).
- (78) V. T. Aleksanyan, G. M. Kuz'yants, M. Yu. Lukina, S. V. Zotova, and E. I. Vostokova, *Zh. Strukt. Khim.*, **9**, 141 (1968); *J. Struct. Chem. (Engl. Transl.)*, **9**, 123 (1968).
- (79) V. T. Aleksanyan, *Opt. Spectrosc. (USSR)*, **29**, 574 (1970).
- (80) A. C. Luntz, *J. Chem. Phys.*, **50**, 1109 (1969).
- (81) J. R. Durig and W. C. Harris, *Spectrochim. Acta, Part A*, **27**, 649 (1971).
- (82) J. R. Durig, Y. S. Li, B. A. Hudgens, and E. A. Cohen, *J. Mol. Spectrosc.*, **63**, 459 (1976).
- (83) C. H. Chlang, R. F. Porter, and S. H. Bauer, *J. Mol. Struct.*, **7**, 89 (1971).
- (84) N. V. Alekseev and P. P. Barzdain, *Zh. Strukt. Khim.*, **15**, 181 (1974); *J. Struct. Chem. (Engl. Transl.)*, **15**, 171 (1974).
- (85) H. P. Lemaire and R. L. Livingston, *J. Am. Chem. Soc.*, **74**, 5732 (1952).
- (86) W. C. Harris and D. B. Yang, *J. Chem. Phys.*, **60**, 4175 (1974).
- (87) F. A. Miller and R. J. Capwell, *Spectrochim. Acta, Part A*, **27**, 1113 (1971).
- (88) F. A. Miller and J. A. Woianin, *Spectrochim. Acta, Part A*, **31**, 1427 (1975).
- (89) W. C. Harris and D. B. Yang, *J. Mol. Struct.*, **18**, 257 (1973).
- (90) J. F. Blanke, T. H. Chao, and J. Laane, *J. Mol. Spectrosc.*, **38**, 483 (1971).
- (91) W. C. Pringle, Jr., *J. Chem. Phys.*, **54**, 4979 (1971).
- (92) V. S. Mastryukov, *Kem. Kozl.*, **37**, 371 (1972); also L. V. Vilkov, V. S. Mastryukov, V. D. Oppenheim, and N. A. Tarasenko in "Molecular Structures and Vibrations", S. J. Cyvin, Ed., Elsevier, Amsterdam, 1972, Chapter 8, p 310.
- (93) V. S. Mastryukov, O. V. Dorofeeva, L. V. Vilkov, B. N. Cyvin, and S. J. Cyvin, *Zh. Strukt. Khim.*, **16**, 473 (1975); *J. Struct. Chem. (Engl. Transl.)*, **16**, 438 (1975).
- (94) J. Laane, *Spectrochim. Acta, Part A*, **26**, 517 (1970).
- (95) B. N. Cyvin, S. J. Cyvin, L. V. Vilkov, and V. S. Mastryukov, *Rev. Chim. Miner.*, **8**, 877 (1971).
- (96) J. D. Lewis, T. H. Chao, and J. Laane, *J. Chem. Phys.*, **62**, 1932 (1975).
- (97) R. M. Irwin, J. M. Cooke, and J. Laane, *J. Am. Chem. Soc.*, **99**, 3273 (1977).
- (98) R. M. Irwin and J. Laane, *J. Mol. Spectrosc.*, **70**, 307 (1978).
- (99) R. M. Irwin and J. Laane, *J. Phys. Chem.*, **82**, 2845 (1978).
- (100) V. S. Mastryukov, O. V. Dorofeeva, L. V. Vilkov, and I. Hargittai, *J. Mol. Struct.*, **34**, 99 (1976).
- (101) O. V. Dorofeeva, V. S. Mastryukov, L. V. Vilkov, and I. Hargittai, *J. Chem. Soc., Chem. Commun.*, 772 (1973).
- (102) L. A. Carreira, R. O. Carter, and J. R. Durig, *J. Chem. Phys.*, **57**, 3384 (1972).
- (103) A. Danti, W. J. Lafferty, and R. C. Lord, *J. Chem. Phys.*, **33**, 294 (1960).
- (104) R. A. Kydd, H. Wieser, and M. Danyluk, *J. Mol. Spectrosc.*, **44**, 14 (1972).
- (105) W. H. Green, *J. Chem. Phys.*, **52**, 2156 (1970).
- (106) H. Wieser, M. Danyluk, and R. A. Kydd, *J. Mol. Spectrosc.*, **43**, 382 (1972).
- (107) W. Kiefer, H. J. Bernstein, H. Wieser, and M. Danyluk, *J. Mol. Spectrosc.*, **43**, 393 (1972).
- (108) H. Wieser and M. Danyluk, *Can. J. Chem.*, **50**, 2761 (1972).
- (109) H. Wieser, M. Danyluk, R. A. Kydd, and H. J. Bernstein, *J. Chem. Phys.*, **61**, 4380 (1974).
- (110) P. D. Mallinson and I. M. Mills, *Mol. Phys.*, **30**, 209 (1975).
- (111) R. A. Creswell, *Mol. Phys.*, **30**, 217 (1975).
- (112) G. L. McKown and R. A. Beaudet, *J. Chem. Phys.*, **55**, 3105 (1971).
- (113) W. C. Pringle, Jr., and A. L. Meinzer, *J. Chem. Phys.*, **61**, 2071 (1974).
- (114) W. C. Harris, A. D. Lopata, and J. R. Durig, *J. Raman Spectrosc.*, **2**, 481 (1974).
- (115) J. A. Duckett, T. L. Smithson, and H. Wieser, *J. Mol. Spectrosc.*, **69**, 159 (1978).
- (116) A. C. Luntz and W. D. Gwinn, *Trans. Am. Crystallogr. Assoc.*, **2**, 90 (1966).
- (117) H. W. Harrington, *J. Chem. Phys.*, **44**, 3481 (1966).
- (118) J. R. Durig and R. C. Lord, *J. Chem. Phys.*, **45**, 61 (1966).
- (119) K. Karakida, K. Kuchitsu, and R. K. Bohn, *Chem. Lett.*, 159 (1974).
- (120) C. J. Nielsen, *Acta Chem. Scand., Ser. A*, **31**, 791 (1977).
- (121) H. Wieser and J. A. Duckett, *J. Mol. Spectrosc.*, **50**, 443 (1974).
- (122) H. Wieser, J. A. Duckett, and R. A. Kydd, *J. Mol. Spectrosc.*, **51**, 115 (1974).
- (123) A. B. Harvey, J. R. Durig, and A. C. Morrissey, *J. Chem. Phys.*, **50**, 4949 (1969).
- (124) M. G. Petit, J. S. Gibson, and D. O. Harris, *J. Chem. Phys.*, **53**, 3408 (1970).
- (125) E. Block, E. R. Corey, R. E. Penn, T. Renken, and P. F. Sherwin, *J. Am. Chem. Soc.*, **98**, 5715 (1976).
- (126) J. R. Durig and R. C. Lord, *Spectrochim. Acta, Part A*, **19**, 769 (1963).
- (127) Z. Smith and R. Seip, *Acta Chem. Scand., Ser. A*, **30**, 759 (1976).
- (128) J. F. Chiang and K. C. Lu, *J. Phys. Chem.*, **81**, 1682 (1977).
- (129) I. Hargittai, *J. Mol. Struct.*, **54**, 287 (1979).
- (130) P. Klaboe and Z. Smith, *Spectrochim. Acta, Part A*, **34**, 489 (1978).
- (131) J. W. Bevan, A. C. Legon, and D. J. Millen, *J. Chem. Soc., Chem. Commun.*, 659 (1974).
- (132) J. W. Bevan, A. C. Legon, and D. J. Millen, *Proc. R. Soc. London, Ser. A*, **354**, 491 (1977).
- (133) L. H. Scharpen and V. W. Laurie, *J. Chem. Phys.*, **49**, 221 (1968).
- (134) A. Bauder, F. Tank, and Hs. H. Günthard, *Helv. Chim. Acta*, **46**, 1453 (1963).
- (135) W. M. Stigliani, V. W. Laurie, and L. H. Scharpen, *J. Mol. Spectrosc.*, **62**, 85 (1976).
- (136) W. C. Harris, R. W. MacNamee, and J. R. van Venrooy, *Appl. Spectrosc.*, **31**, 164 (1977).
- (137) J. R. Durig and W. H. Green, *J. Mol. Spectrosc.*, **27**, 95 (1968).
- (138) J. R. Durig and A. C. Morrissey, *J. Chem. Phys.*, **47**, 4455 (1967).
- (139) L. H. Scharpen and V. W. Laurie, *J. Chem. Phys.*, **49**, 3041 (1968).
- (140) S. H. Bauer and J. Y. Beach, *J. Am. Chem. Soc.*, **84**, 1142 (1962).
- (141) J. R. Durig, Y. S. Li, M. D. Harmony, and M. Y. Fong, *J. Mol. Struct.*, **23**, 377 (1974).
- (142) J. R. Durig and A. C. Morrissey, *J. Chem. Phys.*, **45**, 1269 (1966).
- (143) J. S. Gibson and D. O. Harris, *J. Chem. Phys.*, **52**, 5234 (1970).
- (144) D. W. Boone, C. O. Britt, and J. E. Boggs, *J. Chem. Phys.*, **43**, 1190 (1965).
- (145) L. M. Boggia, P. G. Favero, and O. M. Sorarrain, *Chem. Phys. Lett.*, **12**, 382 (1971).
- (146) J. R. Durig, *Spectrochim. Acta, Part A*, **19**, 1225 (1963).
- (147) N. Kwak, J. W. Simmons, and J. H. Goldstein, *J. Chem. Phys.*, **25**, 1203 (1956).
- (148) L. M. Boggia, O. M. Sorarrain, R. R. Filgueira, and M. C. Villani, *An. Asoc. Quim. Argent.*, **59**, 309 (1971); *Chem. Abstr.*, **77**, 170720s (1972).
- (149) D. Coffey Jr. and M. V. Hershberger, *J. Mol. Spectrosc.*, **59**, 28 (1976).
- (150) J. R. Durig and A. C. Morrissey, *J. Mol. Struct.*, **2**, 377 (1968).
- (151) C. S. Blackwell and R. C. Lord, *J. Mol. Spectrosc.*, **55**, 460 (1975).
- (152) T. K. Avirah, R. L. Cook, and T. B. Malloy Jr., *J. Mol. Spectrosc.*, **55**, 464 (1975).
- (153) B. Bak, J. Led, L. Nygaard, J. Rastrup-Andersen, and G. O. Sørensen, *J. Mol. Struct.*, **3**, 369 (1969).
- (154) H. Kim and W. D. Gwinn, *J. Chem. Phys.*, **42**, 3728L (1965).
- (155) R. C. Lord and D. G. Rea, *J. Am. Chem. Soc.*, **79**, 2401 (1957).
- (156) O. Bastiansen and J. L. Derissen, *Acta Chem. Scand.*, **20**, 1089 (1966).
- (157) E. M. Suzuki and J. W. Nibler, *Spectrochim. Acta, Part A*, **30**, 15 (1974).
- (158) A. C. Legon, *J. Chem. Soc., Chem. Commun.*, 612 (1973).
- (159) A. C. Legon, *J. Chem. Soc., Faraday Trans. 2*, **75**, 651 (1979).
- (160) T. K. Avirah, R. L. Cook, and T. B. Malloy Jr., *J. Mol. Spectrosc.*, **54**, 231 (1975).
- (161) F. A. Miller, F. E. Kiviat, and I. Matsubara, *Spectrochim. Acta, Part A*, **24**, 1523 (1968).
- (162) F. Mönnig, H. Dreizler, and H. D. Rudolf, *Z. Naturforsch. A*, **22**, 1471 (1967).
- (163) J. R. Durig and J. N. Willis Jr., *Spectrochim. Acta, Part A*, **22**, 1299 (1966).

- (184) A. Skancke, *Acta Chem. Scand.*, **22**, 3239 (1968).
- (185) R. D. Brown, F. R. Burden, A. J. Jones, and J. E. Kent, *Chem. Commun.*, 808 (1967).
- (186) R. C. Benson and W. H. Flygare, *J. Chem. Phys.*, **58**, 2366 (1973).
- (187) A. Skancke, *Acta Chem. Scand.*, **27**, 3414 (1973).
- (188) W. Czieslik, L. Carpentier, and D. H. Sutter, *Z. Naturforsch. A*, **29**, 1498 (1974).
- (189) W. Czieslik and D. H. Sutter, *Z. Naturforsch. A*, **29**, 1820 (1974).
- (190) F. A. Miller, F. R. Brown, and K. H. Rhee, *Spectrochim. Acta, Part A*, **28**, 1467 (1972).
- (191) J. R. Durlig, J. N. Willis Jr., and W. H. Green, *J. Chem. Phys.*, **54**, 1547 (1971).
- (192) J. R. Durlig, L. A. Carreira, and J. N. Willis Jr., *J. Chem. Phys.*, **57**, 2755 (1972).
- (193) H. Kim and W. D. Gwinn, *J. Chem. Phys.*, **44**, 865 (1966).
- (194) W. G. Rothschild, *J. Chem. Phys.*, **45**, 3599 (1966).
- (195) J. R. Durlig and A. C. Morrissey, *J. Chem. Phys.*, **48**, 4854 (1967).
- (196) J. R. Durlig, W. H. Green, and N. C. Hammond, *J. Phys. Chem.*, **70**, 1989 (1966).
- (197) C. S. Blackwell, L. A. Carreira, J. R. Durlig, J. M. Karriker, and R. C. Lord, *J. Chem. Phys.*, **56**, 1706 (1972).
- (198) W. G. Rothschild, *J. Chem. Phys.*, **44**, 2213L (1966).
- (199) W. G. Rothschild and B. P. Dalley, *J. Chem. Phys.*, **38**, 2931 (1962).
- (200) J. R. Durlig and W. H. Green, *J. Chem. Phys.*, **47**, 673 (1967).
- (201) J. R. Durlig, A. C. Shing, and L. A. Carreira, *J. Mol. Struct.*, **17**, 423 (1973).
- (202) J. R. Durlig, G. A. Guirgis, W. E. Bucy, D. A. C. Compton, and V. F. Kalasinsky, *J. Mol. Struct.*, **49**, 323 (1978).
- (203) J. N. Macdonald, D. Norbury, and J. Sheridan, *Spectrochim. Acta, Part A*, **34**, 815 (1978).
- (204) J. R. Durlig and W. H. Green, *Spectrochim. Acta, Part A*, **25**, 849 (1969).
- (205) J. R. Durlig, G. A. Guirgis, and V. F. Kalasinsky, *J. Mol. Struct.*, **52**, 27 (1979).
- (206) V. F. Kalasinsky, G. A. Guirgis, and J. R. Durlig, *J. Mol. Struct.*, **39**, 51 (1977).
- (207) M. Y. Fong and M. D. Harmony, *J. Chem. Phys.*, **58**, 4260 (1973).
- (208) J. R. Durlig, L. A. Carreira, and W. J. Lafferty, *J. Mol. Spectrosc.*, **46**, 187 (1973).
- (209) W. J. Adams and L. S. Bartell, *J. Mol. Struct.*, **8**, 199 (1971).
- (210) W. C. Pringle Jr., and A. L. Meizer, *J. Chem. Phys.*, **57**, 2920 (1972).
- (211) W. J. Lafferty, A. G. Maki, and T. D. Coyle, *J. Mol. Spectrosc.*, **33**, 345 (1970).
- (212) L. A. Carreira, J. D. Odom, and J. R. Durlig, *J. Chem. Phys.*, **59**, 4955 (1973).
- (213) L. S. Bartell and B. L. Carroll, *J. Chem. Phys.*, **42**, 1135 (1965).
- (214) K. Kuchitsu, *J. Chem. Phys.*, **49**, 4456 (1968).
- (215) A. C. Ferguson and C. D. Cornwell, *J. Chem. Phys.*, **53**, 1851 (1970).
- (216) A. S. Gaylord and W. C. Pringle Jr., *J. Chem. Phys.*, **59**, 4674 (1973).
- (217) K-K. Lau, A. B. Burg, and R. A. Beaudet, *Inorg. Chem.*, **13**, 2787 (1974).
- (218) E. A. Cohen and R. A. Beaudet, *Inorg. Chem.*, **12**, 1570 (1973).
- (219) W. C. Pringle Jr., C. J. Appeloff, and K. W. Jordan, *J. Mol. Spectrosc.*, **55**, 351 (1975).
- (220) D. F. Eggers, D. A. Kohler, and D. M. Ritter, *Spectrochim. Acta*, **34**, 731 (1978).
- (221) B. L. Carroll and L. S. Bartell, *Inorg. Chem.*, **7**, 219 (1968).
- (222) K. S. Pitzer and W. E. Donath, *J. Am. Chem. Soc.*, **81**, 3213 (1959).
- (223) W. J. Adams, H. J. Geise, and L. S. Bartell, *J. Am. Chem. Soc.*, **92**, 5013 (1970).
- (224) G. N. Zhizhin, J. R. Durlig, J. M. Casper, and T. V. Vasina, *Zh. Strukt. Khim.*, **16**, 56 (1975); *J. Struct. Chem. (Engl. Transl.)*, **16**, 48 (1975).
- (225) T. H. Chao and J. Laane, *J. Mol. Spectrosc.*, **70**, 357 (1978).
- (226) R. Millikan, *U. S. C. F. S. T. I., PB Rep.*, 1968, PB 183476, quoted in *U. S. Gov. Res. Dev. Rep.*, **69**, 74 (1969); *Chem. Abstr.*, **71**, 75958t (1969).
- (227) J. R. Durlig, W. J. Lafferty, and V. F. Kalasinsky, *J. Phys. Chem.*, **80**, 1199 (1976).
- (228) D. L. Philen, T. H. Chao, and J. Laane, *J. Mol. Struct.*, **16**, 417 (1973).
- (229) J. R. Durlig and J. N. Willis Jr., *J. Mol. Spectrosc.*, **32**, 320 (1969).
- (230) Q. Shen, R. L. Hildebrandt, and V. S. Mastryukov, *J. Mol. Struct.*, **54**, 121 (1979).
- (231) J. R. Durlig and J. N. Willis Jr., *J. Chem. Phys.*, **52**, 6108 (1970).
- (232) E. C. Thomas and V. W. Laurie, *J. Chem. Phys.*, **51**, 4327 (1969).
- (233) J. R. Durlig, Y. S. Li, and L. A. Carreira, *J. Chem. Phys.*, **58**, 2393 (1973).
- (234) Z. Smith, H. M. Selp, E. Hengge, and G. Bauer, *Acta Chem. Scand., Ser. A*, **30**, 697 (1976).
- (235) F. Höfler, G. Bauer, and E. Hengge, *Spectrochim. Acta, Part A*, **32**, 1435 (1976).
- (236) K. Hassler, D. Kover, and E. Hengge, *Spectrochim. Acta, Part A*, **34**, 1199 (1978).
- (237) D. W. Wertz and W. E. Shasky, *J. Chem. Phys.*, **55**, 2422 (1971).
- (238) R. C. Loyd, S. N. Mathur, and M. D. Harmony, *J. Mol. Spectrosc.*, **72**, 359 (1978).
- (239) J. R. Durlig, J. M. Karriker, and D. W. Wertz, *J. Mol. Spectrosc.*, **31**, 237 (1969).
- (240) W. C. Harris, J. M. Karriker, and J. R. Durlig, *J. Mol. Struct.*, **9**, 139 (1971).
- (241) I. O. C. Ekejluba and H. E. Hallam, *Spectrochim. Acta, Part A*, **26**, 59, 67 (1970).
- (242) W. J. Lafferty, D. W. Robinson, R. V. St. Louis, J. W. Russell, and H. L. Strauss, *J. Chem. Phys.*, **42**, 2915 (1965).
- (243) H. J. Geise, W. J. Adams, and L. S. Bartell, *Tetrahedron*, **25**, 3045 (1969).
- (244) A. Almenningen, H. M. Selp, and T. Willadsen, *Acta Chem. Scand.*, **23**, 2748 (1969).
- (245) D. W. Wertz, *J. Chem. Phys.*, **51**, 2133 (1969).
- (246) A. Kh. Mamleev and N. M. Posdeev, *Zh. Strukt. Khim.*, **10**, 747 (1969); *J. Struct. Chem. (Engl. Transl.)*, **10**, 643 (1969).
- (247) Z. Nahlovska, B. Nahlovsky, and H. M. Selp, *Acta Chem. Scand.*, **23**, 3534 (1969).
- (248) A. Kh. Mamleev, O. B. Akullinin, and N. M. Posdeev, *Zh. Prikl. Spektroskop.*, **20**, 546 (1974); *Chem. Abstr.*, **81**, 7885y (1974).
- (249) W. H. Green, A. B. Harvey, and J. A. Greenhouse, *J. Chem. Phys.*, **54**, 850 (1971).
- (250) A. Kh. Mamleev, N. M. Posdeev, and N. N. Magdesleva, *J. Mol. Struct.*, **33**, 211 (1976).
- (251) A. Kh. Mamleev, N. N. Magdesleva, and N. M. Posdeev, *Zh. Strukt. Khim.*, **11**, 1124 (1970); *J. Struct. Chem. (Engl. Transl.)*, **11**, 1053 (1970).
- (252) J. R. Durlig and W. J. Natter, *J. Chem. Phys.*, **89**, 3714 (1978).
- (253) Z. Nahlovska, B. Nahlovsky, and H. M. Selp, *Acta Chem. Scand.*, **24**, 1903 (1970).
- (254) J. R. Durlig and D. W. Wertz, *J. Chem. Phys.*, **49**, 675 (1968).
- (255) P. A. Baron and D. O. Harris, *J. Mol. Spectrosc.*, **49**, 70 (1974).
- (256) J. R. Durlig, K. L. Klizer, and J. M. Karriker, *J. Raman Spectrosc.*, **1**, 17 (1973).
- (257) C. W. Gillies and R. L. Kuczkowski, *J. Am. Chem. Soc.*, **94**, 8337 (1972).
- (258) C. W. Gillies and R. L. Kuczkowski, *J. Am. Chem. Soc.*, **94**, 7609 (1972).
- (259) C. W. Gillies, R. L. Kuczkowski, and R. P. Lattimer, *J. Am. Chem. Soc.*, **96**, 1536 (1974).
- (260) R. L. Kuczkowski, C. W. Gillies, and K. L. Gallaher, *J. Mol. Spectrosc.*, **60**, 361 (1976).
- (261) U. Mazur and R. L. Kuczkowski, *J. Mol. Spectrosc.*, **85**, 84 (1977).
- (262) A. Almenningen, P. Kolsaker, H. M. Selp, and T. Willadsen, *Acta Chem. Scand.*, **23**, 3398 (1969).
- (263) R. H. Hunt, R. Leacock, C. N. Peters, and K. T. Hecht, *J. Chem. Phys.*, **42**, 1931 (1965).
- (264) R. P. Lattimer, U. Mazur, and R. L. Kuczkowski, *J. Am. Chem. Soc.*, **98**, 4012 (1976).
- (265) R. P. Lattimer, C. W. Gillies, and R. L. Kuczkowski, *J. Am. Chem. Soc.*, **95**, 1348 (1973).
- (266) R. P. Lattimer, R. L. Kuczkowski, and C. W. Gillies, *J. Am. Chem. Soc.*, **96**, 348 (1974).
- (267) C. W. Gillies, S. P. Sponseller, and R. L. Kuczkowski, *J. Phys. Chem.*, **83**, 1545 (1979).
- (268) J. H. Hand and R. H. Schwendeman, *J. Chem. Phys.*, **45**, 3349 (1966).
- (269) W. V. F. Brooks, C. C. Costain, and R. F. Porter, *J. Chem. Phys.*, **47**, 4186 (1967).
- (270) F. A. Grimm and R. F. Porter, *Inorg. Chem.*, **8**, 731 (1969).
- (271) A. Almenningen, H. M. Selp, and P. Vassbotn, *Acta Chem. Scand.*, **27**, 21 (1973).
- (272) H. M. Selp, R. Selp, and W. Siebert, *Acta Chem. Scand.*, **27**, 15 (1973).
- (273) H. Kim and W. D. Gwinn, *J. Chem. Phys.*, **51**, 1815 (1969).
- (274) J. R. Durlig, G. L. Coulter, and D. W. Wertz, *J. Mol. Spectrosc.*, **27**, 285 (1968).
- (275) H. E. Howard-Lock and G. W. King, *J. Mol. Spectrosc.*, **35**, 393 (1970).
- (276) V. B. Kartha, H. H. Mantsch, and R. N. Jones, *Can. J. Chem.*, **51**, 1749 (1973).
- (277) C. Sablayrolles, L. Bardet, and G. Fleury, *J. Chim. Phys. Physicochim. Biol.*, **88**, 1139 (1969).
- (278) A. Kh. Mamleev, L. N. Gunderova, and N. M. Posdeev, *Zh. Strukt. Khim.*, **19**, 744 (1978); *J. Struct. Chem. (Engl. Transl.)*, **19**, 642 (1978).
- (279) T. Ikeda and R. C. Lord, *J. Chem. Phys.*, **58**, 4450 (1972).
- (280) H. J. Geise and F. C. Mijlhoff, *Recl. Trav. Chim. Pays-Bas*, **90**, 577 (1971).
- (281) J. R. Durlig, Y. S. Li, and L. A. Carreira, *J. Chem. Phys.*, **57**, 1896 (1972).
- (282) T. B. Malloy Jr., F. Fisher, J. Laane, and R. M. Hedges, *J. Mol. Spectrosc.*, **40**, 239 (1971).
- (283) A. C. Legon, *J. Chem. Soc. D*, 838 (1970).
- (284) A. C. Legon, unpublished observations.
- (285) J. R. Durlig, Y. S. Li, and C. C. Tong, *J. Mol. Struct.*, **18**, 269 (1973).
- (286) I. Wang, C. O. Britt, and J. E. Boggs, *J. Am. Chem. Soc.*, **87**, 4950L (1965).
- (287) B. Fortunato, P. Mirone, and G. Fini, *Spectrochim. Acta, Part A*, **27**, 1917 (1971).
- (288) K. Brendhaugen, M. K. Fikke, and H. M. Selp, *Acta Chem. Scand.*, **27**, 1101 (1973).
- (289) A. Almenningen, L. Fernholt, and H. M. Selp, *J. Mol. Struct.*, **49**, 333 (1978).
- (290) G. W. Rathjens, *J. Chem. Phys.*, **38**, 2401 (1962).
- (291) J. R. Durlig and L. A. Carreira, *J. Chem. Phys.*, **58**, 4966 (1972).
- (292) M. I. Davis and T. W. Muecke, *J. Phys. Chem.*, **74**, 1104 (1970).
- (293) T. H. Chao and J. Laane, *Chem. Phys. Lett.*, **14**, 595 (1972).
- (294) W. C. Harris and C. T. Longshore, *J. Mol. Struct.*, **16**, 187 (1973).
- (295) J. Laane, *Adv. Raman Spectrosc.*, **1**, 580 (1972).
- (296) J. R. Villarreal, J. Laane, S. F. Bush, and W. C. Harris, *Spectrochim. Acta, Part A*, **35**, 331 (1979).
- (297) J. R. Villarreal, L. E. Bauman, J. Laane, W. C. Harris, and S. F. Bush, *J. Chem. Phys.*, **63**, 3727 (1975).
- (298) J. R. Villarreal, L. E. Bauman, and J. Laane, *J. Phys. Chem.*, **80**, 1172 (1976).
- (299) T. B. Malloy Jr., *J. Mol. Spectrosc.*, **44**, 504 (1972).
- (300) C. H. Chang and S. H. Bauer, *J. Phys. Chem.*, **75**, 1685 (1971).

- (281) J. R. Durlig, J. M. Karkker, and W. C. Harris, *J. Chem. Phys.*, **52**, 6096 (1970).
- (282) N. N. Veniaminov, N. V. Alekseev, S. A. Bashkirova, N. G. Komalenkova, and E. A. Chernyshev, *Zh. Strukt. Khim.*, **18**, 290 (1975); *J. Struct. Chem. (Engl. Transl.)*, **16**, 267 (1975).
- (283) T. H. Chao and J. Laane, *Spectrochim. Acta, Part A*, **28**, 2443 (1972).
- (284) J. R. Durlig, L. A. Carreira, and J. Laane, *J. Mol. Struct.*, **21**, 281 (1974).
- (285) J. Laane, *J. Chem. Phys.*, **52**, 358 (1970).
- (286) C. R. Nave and K. P. Pullen, *Chem. Phys. Lett.*, **12**, 499 (1972).
- (287) W. H. Green and A. B. Harvey, *Spectrochim. Acta, Part A*, **25**, 723 (1969).
- (288) J. R. Durlig, R. O. Carter, and L. A. Carreira, *J. Chem. Phys.*, **59**, 2249 (1973).
- (289) J. R. Durlig, Y. S. Li, and C. K. Tong, *J. Chem. Phys.*, **56**, 5692 (1972).
- (290) J. R. Durlig, S. Riehlmiller, and Y. S. Li, *J. Chem. Phys.*, **61**, 253 (1974).
- (291) J. D. Lewis and J. Laane, *Spectrochim. Acta, Part A*, **31**, 755 (1975).
- (292) T. H. Chao and J. Laane, *J. Mol. Spectrosc.*, **48**, 266 (1973).
- (293) D. Chadwick, A. C. Legon, and D. J. Millen, *J. Chem. Soc. D*, 1130 (1969).
- (294) D. Chadwick, A. C. Legon, and D. J. Millen, *J. Chem. Soc., Faraday Trans. 2*, **75**, 302 (1979).
- (295) A. C. Legon, unpublished observations.
- (296) K. L. Dorris, C. O. Britt, and J. E. Boggs, *J. Chem. Phys.*, **44**, 1352 (1966).
- (297) W. F. White and J. E. Boggs, *J. Chem. Phys.*, **54**, 4714 (1971).
- (298) J. R. Durlig, J. W. Clark, and J. M. Casper, *J. Mol. Struct.*, **5**, 67 (1970).
- (299) B. Bak, O. Nielsen, H. Svanholt, A. Almenningen, O. Bastiansen, L. Fernholt, G. Gundersen, C. J. Nielsen, B. N. Cyvin, and S. J. Cyvin, *Acta Chem. Scand., Ser. A*, **32**, 1005 (1978).
- (300) P. J. Mjoberg, S. O. Ljunggren, and J. E. Backvall, *Z. Naturforsch. A*, **33**, 581 (1978).
- (301) K. Hagen and K. Hedberg, *J. Mol. Struct.*, **44**, 195 (1978).
- (302) B. Fortunato and M. G. Giogini, *J. Mol. Struct.*, **37**, 27 (1977).
- (303) R. L. Hilderbrandt and E. M. A. Peixoto, *J. Mol. Struct.*, **12**, 31 (1972).
- (304) A. Rogstad, P. Klæboe, H. F. Baranska, B. N. Cyvin, and S. J. Cyvin, *J. Mol. Struct.*, **20**, 403 (1974).
- (305) O. L. Stiefvater, *Z. Naturforsch. A*, **32**, 1480 (1977).
- (306) K. Hagen and K. Hedberg, *J. Mol. Struct.*, **50**, 103 (1978).
- (307) L. H. Scharpen and V. W. Laurie, *J. Chem. Phys.*, **43**, 2765 (1965).
- (308) D. Damiani, L. Ferretti, and E. Gallinella, *Chem. Phys. Lett.*, **37**, 265 (1976).
- (309) E. Gallinella, B. Fortunato, and P. Mirone, *J. Mol. Spectrosc.*, **24**, 345 (1967).
- (310) B. Fortunato, E. Gallinella, and P. Mirone, *Gazz. Chim. Ital.*, **101**, 543 (1971).
- (311) C. H. Chang and S. H. Bauer, *J. Phys. Chem.*, **75**, 1685 (1971).
- (312) R. G. Ford and H. A. Seltzman, *J. Mol. Spectrosc.*, **69**, 326 (1978).
- (313) P. A. Baron and R. D. Brown, *Chem. Phys.*, **1**, 444 (1973).
- (314) P. A. Baron, R. D. Brown, F. R. Burden, P. J. Domaille, and J. E. Kent, *J. Mol. Spectrosc.*, **43**, 401 (1972).
- (315) R. D. Suenram and M. D. Harmony, *J. Chem. Phys.*, **58**, 5842 (1973).
- (316) R. D. Brown, F. R. Burden, and J. E. Kent, *J. Chem. Phys.*, **49**, 5542 (1968).
- (317) P. J. Domaille, J. E. Kent, and M. F. O'Dwyer, *Aust. J. Chem.*, **27**, 2463 (1974).
- (318) R. D. Brown, P. J. Domaille, and J. E. Kent, *Aust. J. Chem.*, **23**, 1707 (1970).
- (319) J. F. Chiang and S. H. Bauer, *J. Am. Chem. Soc.*, **92**, 261 (1970).
- (320) A. Skancke, *Acta Chem. Scand.*, **27**, 1735 (1973).
- (321) H. M. Pickett, *J. Am. Chem. Soc.*, **95**, 1770 (1973).
- (322) L. Nygaard, J. T. Nielsen, J. Kirchner, G. Maitesen, J. Rastrup-Andersen, and G. O. Sørensen, *J. Mol. Struct.*, **3**, 491 (1969).
- (323) B. Bak, D. Christensen, L. Hansen, J. Rastrup-Andersen, *J. Chem. Phys.*, **24**, 720 (1956).
- (324) K. M. Marstokk and H. Møllendal, *J. Mol. Struct.*, **23**, 93 (1974).
- (325) B. Bak, D. Christensen, W. B. Dixon, L. Hansen-Nygaard, J. Rastrup-Andersen, and M. Schöttlander, *J. Mol. Spectrosc.*, **9**, 124 (1962).
- (326) F. Mata, M. C. Martin, and G. O. Sørensen, *J. Mol. Struct.*, **48**, 157 (1978).
- (327) U. Andresen and H. Dreizler, *Z. Naturforsch. A*, **25**, 570 (1970).
- (328) T. Ogata and K. Kozima, *Bull. Chem. Soc. Jpn.*, **44**, 2344 (1971).
- (329) T. Kojima, T. Ogata, and S. Maeda, *Chem. Lett.*, 607 (1976).
- (330) L. Engelbrecht and D. H. Sutter, *Z. Naturforsch. A*, **31**, 670 (1976).
- (331) B. Bak, D. Christensen, L. Hansen-Nygaard, and J. Rastrup-Andersen, *J. Mol. Spectrosc.*, **7**, 58 (1961).
- (332) B. Bak, D. Christensen, J. Rastrup-Andersen, and E. Tannenbaum, *J. Chem. Phys.*, **25**, 892 (1956).
- (333) R. A. Bonham and F. A. Momany, *J. Phys. Chem.*, **67**, 2474 (1963).
- (334) S. H. Bauer and W. Harshberger, *Acta Crystallogr., Sect. B*, **26**, 1010 (1970).
- (335) T. Ogata and K. Kozima, *J. Mol. Spectrosc.*, **42**, 38 (1972).
- (336) L. N. Gunderova, A. A. Shapkin, and N. M. Posdeev, *Opt. Spectrosc. (USSR)*, **34**, 703 (1973).
- (337) R. R. Karl and S. H. Bauer, *Acta Crystallogr., Sect. B*, **28**, 2619 (1972).
- (338) J. L. Derissen, J. W. M. Kocken, and R. H. van Weelden, *Acta Crystallogr., Sect. B*, **27**, 1692 (1971).
- (339) P. J. Mjoberg and S. O. Ljunggren, *Z. Naturforsch. A*, **28**, 729 (1973).
- (340) P. J. Mjoberg, W. M. Ralowski, and S. O. Ljunggren, *Z. Naturforsch. A*, **30**, 541 (1975).
- (341) T. K. Avirah, T. B. Malloy Jr., and R. L. Cook, *J. Mol. Struct.*, **29**, 47 (1975).
- (342) J. Wiese and D. H. Sutter, *Z. Naturforsch. A*, **32**, 890 (1977).
- (343) W. Ralowski and S. O. Ljunggren, *Acta Chem. Scand., Ser. A*, **31**, 492 (1977).
- (344) M. K. Isven, W. M. Ralowski, and S. O. Ljunggren, *Chem. Phys. Lett.*, **47**, 294 (1977).
- (345) F. Mönnig, H. Dreizler, and H. D. Rudolf, *Z. Naturforsch. A*, **20**, 1323 (1965).
- (346) N. M. Posdeev, O. B. Akulinin, A. A. Shapkin, and N. N. Magdesieva, *Zh. Strukt. Khim.*, **11**, 869 (1970); *J. Struct. Chem. (Engl. Transl.)*, **11**, 804 (1970).
- (347) R. D. Brown, F. R. Burden, and P. D. Godfrey, *J. Mol. Spectrosc.*, **25**, 415 (1968).
- (348) R. D. Brown and J. G. Crofts, *Chem. Phys.*, **1**, 217 (1973).
- (349) L. Nygaard, D. Christensen, J. T. Nielsen, E. J. Pedersen, O. Snerling, E. Vestergaard, and G. O. Sørensen, *J. Mol. Struct.*, **22**, 401 (1974).
- (350) N. M. Posdeev, R. S. Nasibullin, R. G. Latypova, V. G. Vinokurov, and N. D. Konevskaya, *Opt. Spectrosc. (USSR)*, **31**, 32 (1971).
- (351) R. S. Nasibullin, R. G. Latypova, V. S. Troitskaya, V. G. Vinokurov, and N. M. Posdeev, *Zh. Strukt. Khim.*, **15**, 41 (1974); *J. Struct. Chem. (Engl. Transl.)*, **15**, 41 (1974).
- (352) G. L. Blackman, R. D. Brown, F. R. Burden, and I. R. Elsum, *J. Mol. Spectrosc.*, **80**, 63 (1976).
- (353) J. H. Griffiths, A. Wardley, V. E. Williams, N. L. Owen, and J. Sheridan, *Nature (London)*, **218**, 1301 (1967).
- (354) A. Kumar, J. Sheridan, and O. L. Stiefvater, *Z. Naturforsch. A*, **33**, 145 (1978).
- (355) O. L. Stiefvater, *Z. Naturforsch. A*, **33**, 153 (1978).
- (356) G. Sbrana, E. Castellucci, and M. Ginanneschi, *Spectrochim. Acta, Part A*, **23**, 751 (1967).
- (357) O. L. Stiefvater, *J. Chem. Phys.*, **63**, 2560 (1975).
- (358) O. L. Stiefvater, P. Nösberger, and J. Sheridan, *Chem. Phys.*, **9**, 435 (1975).
- (359) L. Nygaard, E. Asmussen, J. H. Høg, R. C. Maheshwari, C. H. Nielsen, I. B. Petersen, J. Rastrup-Andersen, and G. O. Sørensen, *J. Mol. Spectrosc.*, **8**, 225 (1971).
- (360) J.-L. Meyer, G. Davidovics, J. Chouteau, J.-C. Poite, and J. Roggero, *Can. J. Chem.*, **49**, 2254 (1971).
- (361) G. E. Andreoletti and P. Sampletro, *Spectrochim. Acta, Part A*, **23**, 2647 (1967).
- (362) E. Saegbarth and A. P. Cox, *J. Chem. Phys.*, **43**, 166 (1965).
- (363) G. Sbrana, M. Ginanneschi, and M. P. Marzocchi, *Spectrochim. Acta, Part A*, **23**, 1757 (1967).
- (364) D. H. Christensen and O. F. Nielsen, *J. Mol. Spectrosc.*, **24**, 477 (1967).
- (365) D. H. Christensen, P. W. Jensen, J. T. Nielsen, and O. F. Nielsen, *Spectrochim. Acta, Part A*, **29**, 1393 (1973).
- (366) T. Stroyer-Hansen, *Acta Chem. Scand., Ser. A*, **28**, 811 (1974).
- (367) L. Nygaard, R. L. Hansen, J. T. Nielsen, J. Rastrup-Andersen, G. O. Sørensen, and P. A. Steiner, *J. Mol. Struct.*, **12**, 59 (1972).
- (368) D. H. Christensen, J. T. Nielsen, and O. F. Nielsen, *J. Mol. Spectrosc.*, **24**, 225 (1967).
- (369) J. W. Anthonson, D. H. Christensen, J. T. Nielsen, and O. F. Nielsen, *Spectrochim. Acta, Part A*, **32**, 971 (1976).
- (370) O. L. Stiefvater, *Chem. Phys.*, **13**, 73 (1976).
- (371) O. L. Stiefvater, *Z. Naturforsch. A*, **31**, 1681 (1976).
- (372) V. Dobyans and L. Pierce, *J. Am. Chem. Soc.*, **85**, 3553 (1963).
- (373) F. A. Momany and R. A. Bonham, *J. Am. Chem. Soc.*, **86**, 162 (1964).
- (374) E. Benedetti, G. Sbrana, and V. Bertini, *Gazz. Chim. Ital.*, **97**, 379 (1967).
- (375) L. Nygaard, R. L. Hansen, and G. O. Sørensen, *J. Mol. Struct.*, **9**, 163 (1971).
- (376) P. Markov and R. Støvelk, *Acta Chem. Scand.*, **24**, 2525 (1970).
- (377) B. Bak, L. Nygaard, E. J. Pedersen, and J. Rastrup-Andersen, *J. Mol. Spectrosc.*, **19**, 283 (1966).
- (378) D. H. Christensen and T. Stroyer-Hansen, *Acta Chem. Scand.*, **28**, 923 (1972).
- (379) D. H. Christensen and T. Stroyer-Hansen, *Spectrochim. Acta, Part A*, **28**, 2057 (1970).
- (380) G. L. Blackman, R. D. Brown, F. R. Burden, and J. E. Kent, *Chem. Phys. Lett.*, **1**, 379 (1967).
- (381) E. Benedetti and V. Bertini, *Spectrochim. Acta, Part A*, **24**, 57 (1968).
- (382) D. M. Levine, W. D. Krugh, and L. P. Gold, *J. Mol. Spectrosc.*, **30**, 459 (1969).
- (383) O. L. Stiefvater, H. Jones, and J. Sheridan, *Spectrochim. Acta, Part A*, **28**, 825 (1970).
- (384) G. O. Sørensen, L. Nygaard, and M. Begtrup, *J. Chem. Soc., Chem. Commun.*, 605 (1974).
- (385) J. F. Chiang and K. C. Lu, *J. Mol. Struct.*, **41**, 223 (1977).
- (386) K. Bolton, R. D. Brown, F. R. Burden, and A. Mishra, *J. Mol. Struct.*, **27**, 261 (1975).
- (387) W. D. Krugh and L. P. Gold, *J. Mol. Spectrosc.*, **49**, 423 (1974).
- (388) R. D. Suenram and M. D. Harmony, *J. Chem. Phys.*, **58**, 3837 (1972).
- (389) R. K. Bohn and Y.-H. Tai, *J. Am. Chem. Soc.*, **92**, 6447 (1970).
- (390) S. L. Hsu, A. H. Andrist, T. D. Gierke, R. C. Benson, W. H. Flygare, and J. E. Baldwin, *J. Am. Chem. Soc.*, **92**, 5250L (1970).
- (391) J. F. Chiang, M. T. Kratus, A. L. Andreaassen, and S. H. Bauer, *J. Chem. Soc., Faraday Trans. 2*, **68**, 1274 (1972).
- (392) A. Almenningen, B. Andersen, and B. A. Nyhus, *Acta Chem. Scand.*, **25**, 1217 (1971).
- (393) K. W. Cox and M. D. Harmony, *J. Mol. Spectrosc.*, **38**, 34 (1970).
- (394) B. Andersen and R. Srinivasan, *Acta Chem. Scand.*, **28**, 3468 (1972).
- (395) E. A. McNeill and F. R. Scholer, *J. Mol. Struct.*, **31**, 65 (1976).
- (396) D. W. T. Griffith and J. E. Kent, *Chem. Phys. Lett.*, **25**, 290 (1974).
- (397) B. Ahlquist, B. Andersen, and H. M. Selp, *J. Mol. Struct.*, **22**, 141 (1974).

- (398) M. J. Cardillo and S. H. Bauer, *J. Am. Chem. Soc.*, **92**, 2399 (1970).
(399) J. F. Chiang, *J. Am. Chem. Soc.*, **93**, 5044 (1971).
(400) C. H. Wang and M. D. Harmony, *J. Am. Chem. Soc.*, **98**, 1108 (1976).
(401) D. L. Zebelmann, S. H. Bauer, and J. F. Chiang, *Tetrahedron*, **28**, 2727 (1972).
(402) J. F. Chiang and K. C. Lu, *Tetrahedron*, **34**, 867 (1978).
(403) T. Fukuyama, K. Oyanagi, and K. Kuchitsu, *Bull. Chem. Soc. Jpn.*, **49**, 638 (1976).
(404) D. Coffey Jr. and T. E. Hooker, *J. Mol. Spectrosc.*, **40**, 158 (1971).
(405) D. Coffey Jr., *J. Mol. Spectrosc.*, **42**, 47 (1972).
(406) R. C. Lord and T. B. Malloy Jr., *J. Mol. Spectrosc.*, **48**, 358 (1973).
(407) R. L. Cook and T. B. Malloy Jr., *J. Am. Chem. Soc.*, **96**, 1703 (1974).
(408) J. D. Lewis, J. Laane, and T. B. Malloy Jr., *J. Chem. Phys.*, **61**, 2342 (1974).
(409) V. S. Mastryukov, E. L. Osina, L. V. Vilkov, and R. L. Hilderbrandt, *J. Am. Chem. Soc.*, **99**, 6855 (1977).
(410) T. B. Malloy Jr., *J. Mol. Spectrosc.*, **49**, 432 (1974).
(411) W. J. Lafferty, *J. Mol. Spectrosc.*, **36**, 84 (1970).
(412) R. L. Hilderbrandt and J. D. Wieser, *J. Mol. Struct.*, **22**, 247 (1974).
(413) R. A. Creswell and W. J. Lafferty, *J. Mol. Spectrosc.*, **46**, 371 (1973).
(414) P. J. Mjoberg, W. M. Ralowski, S. O. Ljunggren, and J. E. Backvall, *J. Mol. Spectrosc.*, **80**, 179 (1976).
(415) J. W. Bevan, A. C. Legon, S. O. Ljunggren, and P. J. Mjoberg, *J. Am. Chem. Soc.*, **100**, 8161 (1978).
(416) Z. Kisiel and A. C. Legon, *J. Am. Chem. Soc.*, **100**, 8166 (1978).
(417) S. N. Mathur and M. D. Harmony, *J. Mol. Spectrosc.*, **69**, 37 (1978).
(418) J. R. Villarreal and J. Laane, *J. Chem. Phys.*, **68**, 3298 (1978).
(419) J. F. Chiang and S. H. Bauer, *J. Am. Chem. Soc.*, **88**, 420 (1966).
(420) T. K. Avirah, R. L. Cook, and T. B. Malloy Jr., *Symp. Mol. Struct. Spectrosc. (Ohio)*, 1974, Paper TB5; *J. Chem. Phys.*, **71**, 3478 (1979).
(421) A. Yokozeki and K. Kuchitsu, *Bull. Chem. Soc. Jpn.*, **44**, 2356 (1971).
(422) Y. Morino, K. Kuchitsu, and A. Yokozeki, *Bull. Chem. Soc. Jpn.*, **40**, 1552 (1967).
(423) J. F. Chiang, C. F. Wilcox Jr., and S. H. Bauer, *J. Am. Chem. Soc.*, **90**, 3149 (1968).
(424) T. Ikeura, K. Tanaka, E. Hirota, S. Inaba, and Y. Nagai, *Bull. Chem. Soc. Jpn.*, **50**, 1309 (1977).
(425) R. L. Hilderbrandt, G. D. Horner, and P. Boudjouk, *J. Am. Chem. Soc.*, **98**, 7476 (1976).
(426) K. Oyanagi, T. Fukuyama, K. Kuchitsu, R. K. Bohn, and S-T. Li, *Bull. Chem. Soc. Jpn.*, **48**, 751 (1975).
(427) R. A. Creswell, *J. Mol. Spectrosc.*, **56**, 133 (1975).
(428) J. R. Durig, A. D. Lopata, and Y. S. Li, *J. Mol. Struct.*, **26**, 85 (1975).
(429) J. F. Chiang, R. L. Chiang, K. C. Lu, E-M. Sung, and M. D. Harmony, *J. Mol. Struct.*, **41**, 67 (1977).
(430) R. D. Suenram, *J. Mol. Struct.*, **33**, 1 (1976).
(431) J. F. Chiang, R. L. Chiang, and M. T. Kratus, *J. Mol. Struct.*, **26**, 175 (1975).
(432) L. van den Enden, H. J. Geise, H. P. Figeys, P. Geerlings, and C. van Alsenoy, *J. Mol. Struct.*, **33**, 69 (1976).
(433) R. D. Suenram, *J. Am. Chem. Soc.*, **97**, 4869 (1975).
(434) B. Andersen and L. Fernholt, *Acta Chem. Scand., Ser. A*, **24**, 445 (1970).
(435) Z. Smith, B. Andersen, and S. Bunce, *Acta Chem. Scand., Ser. A*, **31**, 557 (1977).
(436) Y. C. Wang and S. H. Bauer, *J. Am. Chem. Soc.*, **94**, 5651 (1972).
(437) R. D. Suenram and M. D. Harmony, *J. Am. Chem. Soc.*, **95**, 4506 (1973).
(438) R. R. Karl Jr. and S. H. Bauer, *J. Mol. Struct.*, **25**, 1 (1975).
(439) J. F. Chiang and S. H. Bauer, *Trans. Faraday Soc.*, **64**, 2247 (1968).
(440) R. K. Bohn, K. Mizuno, T. Fukuyama, and K. Kuchitsu, *Bull. Chem. Soc. Jpn.*, **46**, 1395 (1973).
(441) K. Mizuno, T. Fukuyama, and K. Kuchitsu, *Chem. Lett.*, 249 (1972).
(442) L. A. Carreira, R. C. Lord, and T. B. Malloy, Jr., *Top. Curr. Chem.*, **62**, 1 (1979).
(443) O. Bastiansen, K. Kveseth, and H. Møllendal, *Top. Curr. Chem.*, **61**, 99 (1979).
(444) J. A. Duckett, T. L. Smithson, and H. Wieser, *J. Mol. Struct.*, **58**, 157 (1979).
(445) G. Schultz and M. Bartok, *Z. Naturforsch. A*, **34**, 1130 (1979).
(446) T. Stroyer-Hansen and E. Nørby Svendsen, *Spectrochim. Acta, Part A*, **36**, 359 (1980).
(447) J. R. Durig, D. A. C. Compton, and M. Johnson-Streusand, *J. Mol. Struct.*, **56**, 175 (1979).
(448) T. B. Malloy, Jr., and L. A. Carreira, *J. Chem. Phys.*, **71**, 2488 (1979).
(449) L. Halonen, E. Friz, A. G. Robiette, and I. M. Mills, *J. Mol. Spectrosc.*, **79**, 432 (1980).
(450) V. S. Mastryukov, A. V. Golubinskii, E. G. Atavin, L. V. Vilkov, B. N. Cyvin, and S. J. Cyvin, *Zh. Strukt. Khim.*, **20**, 726 (1979).